

Chapter 5

Multi-Dimensional Indexing

Indexing Points and Regions in k Dimensions

Architecture and Implementation of Database Systems
Winter 2010/11

B+-trees...

... over composite keys

Point Quad Trees

Point (Equality) Search
Inserting Data
Region Queries

k-d Trees

Balanced Construction

K-D-B-Trees

K-D-B-Tree Operations
Splitting a Point Page
Splitting a Region Page

R-Trees

Searching and Inserting
Splitting R-Tree Nodes

UB-Trees

Bit Interleaving / Z-Ordering
B+-Trees over Z-Codes
Range Queries

Spaces with High Dimensionality

Wrap-Up

Torsten Grust
Wilhelm-Schickard-Institut für Informatik
Universität Tübingen



More Dimensions...

One SQL query, many range predicates

```
1 SELECT *
2 FROM CUSTOMERS
3 WHERE ZIPCODE BETWEEN 8880 AND 8999
4 AND REVENUE BETWEEN 3500 AND 6000
```

This query involves a **range predicate** in **two** dimensions.

Typical use cases for **multi-dimensional data** include

- **geographical data** (GIS: Geographical Information Systems),
- **multimedia retrieval** (e.g., image or video search),
- **OLAP** (Online Analytical Processing),
- queries against **encoded data** (e.g., XML)

Multi-Dimensional Indexing

Torsten Grust

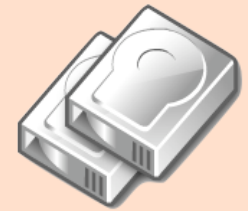

B+-trees...

... over composite keys

Point Quad Trees

Point (Equality) Search

Inserting Data

Region Queries

k-d Trees

Balanced Construction

K-D-B-Trees

K-D-B-Tree Operations

Splitting a Point Page

Splitting a Region Page

R-Trees

Searching and Inserting

Splitting R-Tree Nodes

UB-Trees

Bit Interleaving / Z-Ordering

B+-Trees over Z-Codes

Range Queries

Spaces with High Dimensionality

Wrap-Up

... More Challenges...

Queries and data can be points or regions

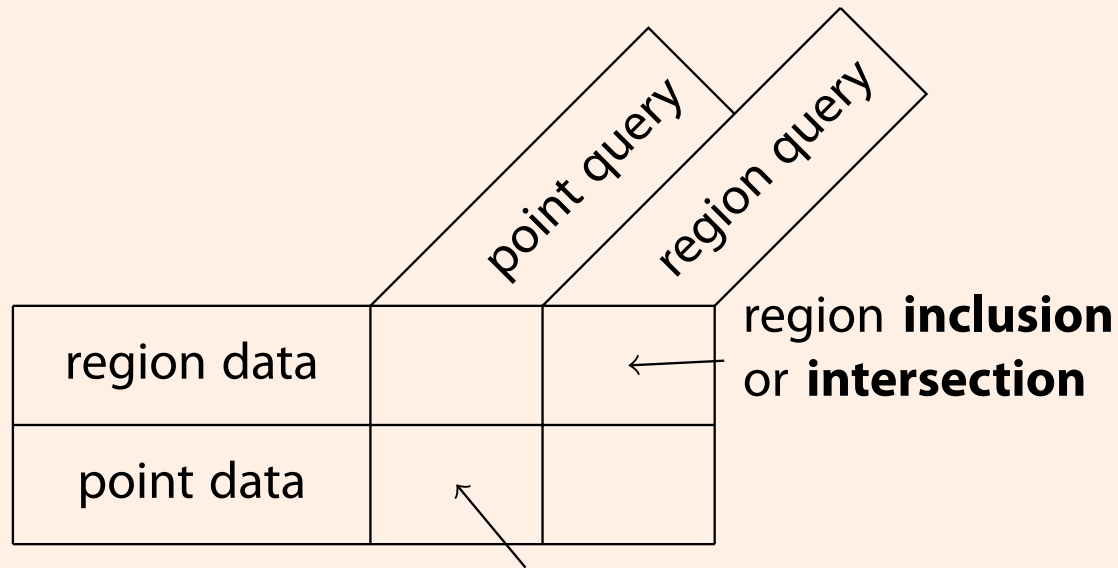

... and you can come up with many more meaningful types of queries over multi-dimensional data.

Note: All equality searches can be reduced to one-dimensional queries.

Multi-Dimensional Indexing

Torsten Grust

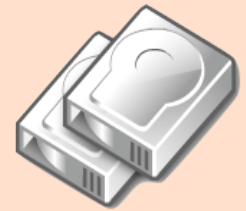

B+-trees...

... over composite keys

Point Quad Trees

Point (Equality) Search
Inserting Data
Region Queries

k-d Trees

Balanced Construction

K-D-B-Trees

K-D-B-Tree Operations
Splitting a Point Page
Splitting a Region Page

R-Trees

Searching and Inserting
Splitting R-Tree Nodes

UB-Trees

Bit Interleaving / Z-Ordering
B+-Trees over Z-Codes
Range Queries

Spaces with High Dimensionality

Wrap-Up

Points, Lines, and Regions

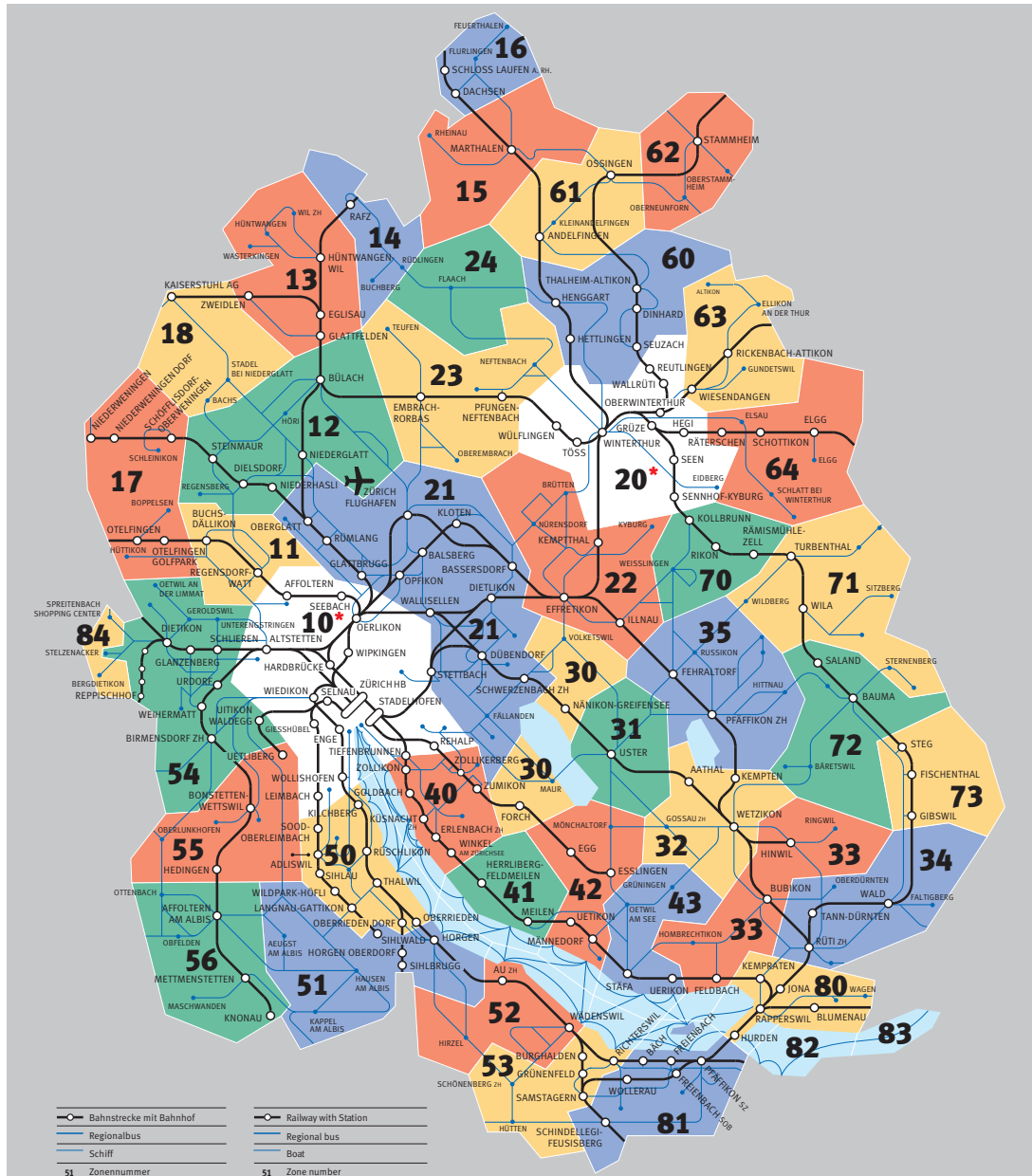

Multi-Dimensional Indexing

Torsten Grust

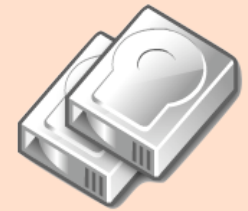

B+-trees...

... over composite keys

Point Quad Trees

Point (Equality) Search

Inserting Data

Region Queries

k-d Trees

Balanced Construction

K-D-B-Trees

K-D-B-Tree Operations

Splitting a Point Page

Splitting a Region Page

R-Trees

Searching and Inserting

Splitting R-Tree Nodes

UB-Trees

Bit Interleaving / Z-Ordering

B+-Trees over Z-Codes

Range Queries

Spaces with High Dimensionality

Wrap-Up

... More Solutions

Recent proposals for multi-dimension index structures

Quad Tree [Finkel 1974]	K-D-B-Tree [Robinson 1981]
R-tree [Guttman 1984]	Grid File [Nievergelt 1984]
R ⁺ -tree [Sellis 1987]	LSD-tree [Henrich 1989]
R*-tree [Geckmann 1990]	hB-tree [Lomet 1990]
Vp-tree [Chiueh 1994]	TV-tree [Lin 1994]
UB-tree [Bayer 1996]	hB- Π -tree [Evangelidis 1995]
SS-tree [White 1996]	X-tree [Berchtold 1996]
M-tree [Ciaccia 1996]	SR-tree [Katayama 1997]
Pyramid [Berchtold 1998]	Hybrid-tree [Chakrabarti 1999]
DABS-tree [Böhm 1999]	IQ-tree [Böhm 2000]
Slim-tree [Faloutsos 2000]	Landmark file [Böhm 2000]
P-Sphere-tree [Goldstein 2000]	A-tree [Sakurai 2000]

None of these provides a “fits all” solution.

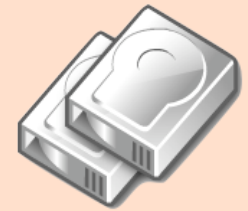

B+-trees...

... over composite keys

Point Quad Trees

Point (Equality) Search

Inserting Data

Region Queries

k-d Trees

Balanced Construction

K-D-B-Trees

K-D-B-Tree Operations

Splitting a Point Page

Splitting a Region Page

R-Trees

Searching and Inserting

Splitting R-Tree Nodes

UB-Trees

Bit Interleaving / Z-Ordering

B+-Trees over Z-Codes

Range Queries

Spaces with High Dimensionality

Wrap-Up

Can We Just Use a B⁺-tree?

- Can two B⁺-trees, one over ZIPCODE and over REVENUE, adequately support a two-dimensional range query?

Querying a rectangle

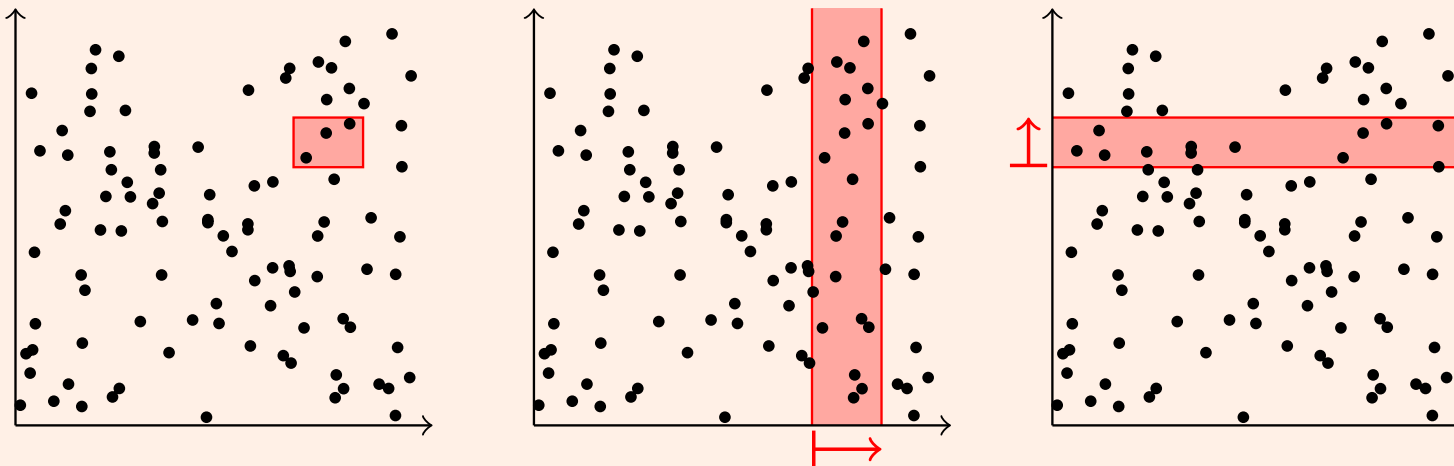

- Can only scan along **either** index at once, and both of them produce many **false hits**.
- If all you have are these two indices, you can do **index intersection**: perform both scans in separation to obtain the *rids* of candidate tuples. Then compute the intersection between the two *rid* lists (DB2: IXAND).

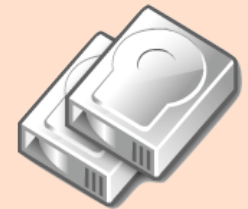

B⁺-trees...

... over composite keys

Point Quad Trees

Point (Equality) Search
Inserting Data
Region Queries

k-d Trees

Balanced Construction

K-D-B-Trees

K-D-B-Tree Operations
Splitting a Point Page
Splitting a Region Page

R-Trees

Searching and Inserting
Splitting R-Tree Nodes

UB-Trees

Bit Interleaving / Z-Ordering
B⁺-Trees over Z-Codes
Range Queries

Spaces with High Dimensionality

Wrap-Up

IBM DB2: Index Intersection

DB2[®] IBM DB2 uses index intersection (operator IXAND)

```
1 SELECT *
2 FROM ACCEL
3 WHERE PRE BETWEEN 0 AND 10000
4 AND POST BETWEEN 10000 AND 20000
```

Relevant indexes defined over table ACCEL:

- 1 IPOST over column POST
- 2 SQL0801192024500 over column PRE (primary key)

DB2[®] Plan selected by the query optimizer

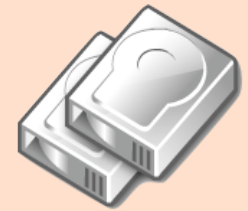
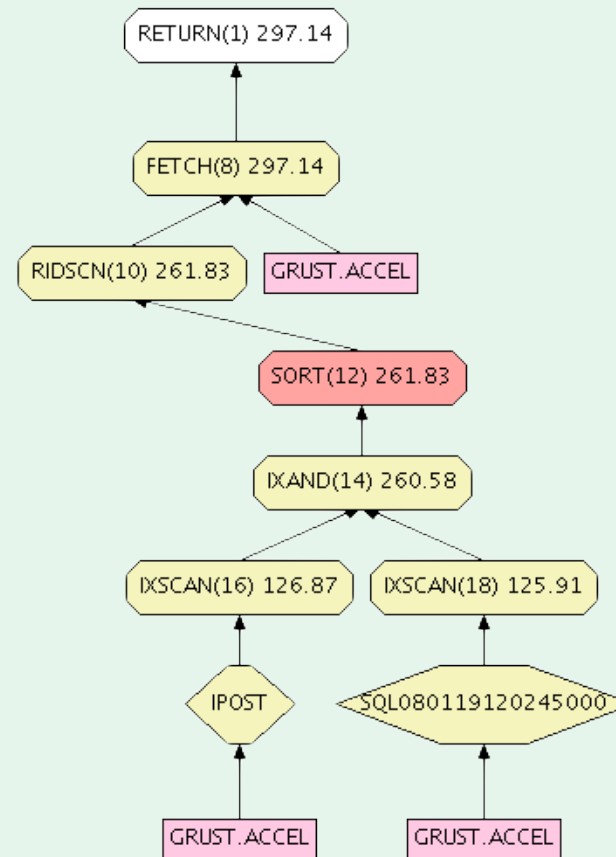

B+-trees...

... over composite keys

Point Quad Trees

Point (Equality) Search
Inserting Data
Region Queries

k-d Trees

Balanced Construction

K-D-B-Trees

K-D-B-Tree Operations
Splitting a Point Page
Splitting a Region Page

R-Trees

Searching and Inserting
Splitting R-Tree Nodes

UB-Trees

Bit Interleaving / Z-Ordering
B+-Trees over Z-Codes
Range Queries

Spaces with High Dimensionality

Wrap-Up

Can Composite Keys Help?

Indexes with composite keys

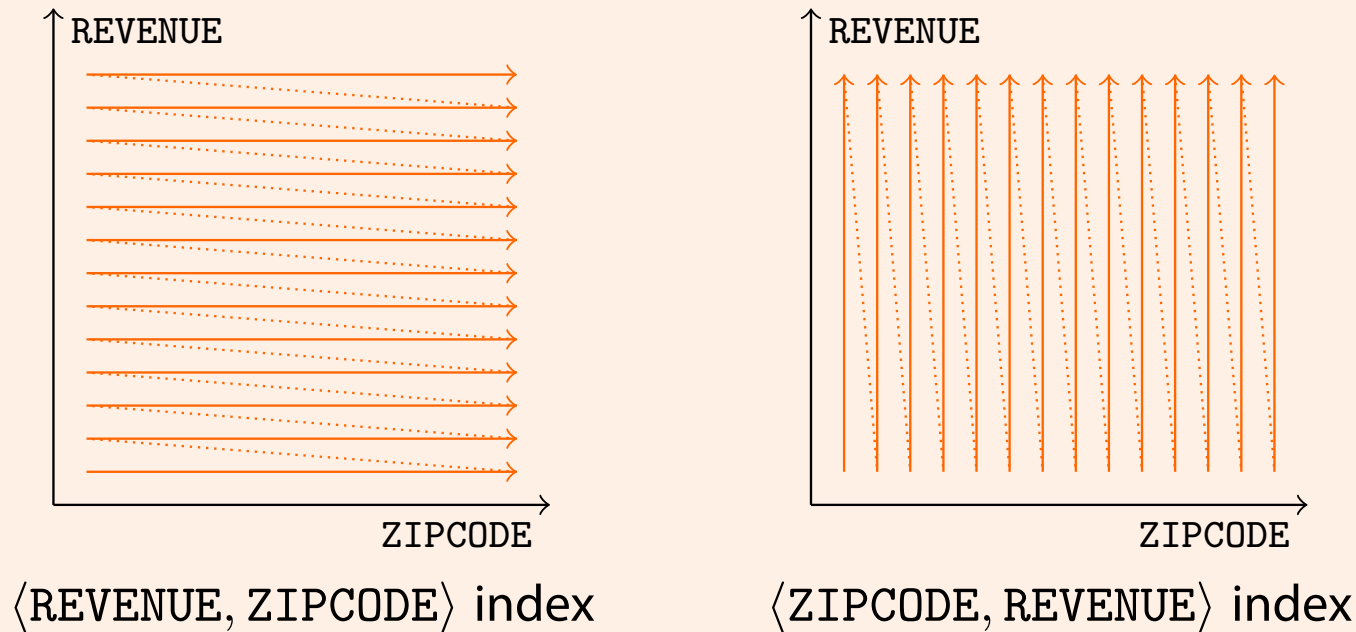

- **Almost the same thing!**
Indices over composite keys are **not symmetric**: The major attribute dominates the organization of the B⁺-tree.
- **But:** Since the minor attribute is also stored in the index (part of the keys k), we may discard non-qualifying tuples **before** fetching them from the data pages.

Multi-Dimensional Indexing

Torsten Grust

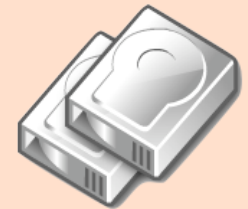

B⁺-trees...

... over composite keys

Point Quad Trees

Point (Equality) Search
Inserting Data
Region Queries

k-d Trees

Balanced Construction

K-D-B-Trees

K-D-B-Tree Operations
Splitting a Point Page
Splitting a Region Page

R-Trees

Searching and Inserting
Splitting R-Tree Nodes

UB-Trees

Bit Interleaving / Z-Ordering
B⁺-Trees over Z-Codes
Range Queries

Spaces with High Dimensionality

Wrap-Up

Multi-Dimensional Indices

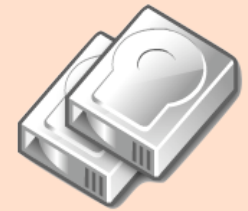

B+-trees...

... over composite keys

Point Quad Trees

Point (Equality) Search

Inserting Data

Region Queries

k-d Trees

Balanced Construction

K-D-B-Trees

K-D-B-Tree Operations

Splitting a Point Page

Splitting a Region Page

R-Trees

Searching and Inserting

Splitting R-Tree Nodes

UB-Trees

Bit Interleaving / Z-Ordering

B+-Trees over Z-Codes

Range Queries

Spaces with High Dimensionality

Wrap-Up

- B⁺-trees can answer **one-dimensional** queries **only**.¹
- We would like to have a **multi-dimensional index structure** that
 - is **symmetric** in its dimensions,
 - **clusters** data in a space-aware fashion,
 - is **dynamic** with respect to updates, and
 - provides good support for useful queries.
- We will start with data structures that have been designed for **in-memory** use, then tweak them into **disk-aware** database indices (e.g., organize data in a page-wise fashion).

¹Toward the end of this chapter, we will see UB-trees, a nifty trick that uses B⁺-trees to support some multi-dimensional queries.

“Binary” Search Tree

In k dimensions, a “**binary tree**” becomes a 2^k -ary tree.

Point quad tree ($k = 2$)

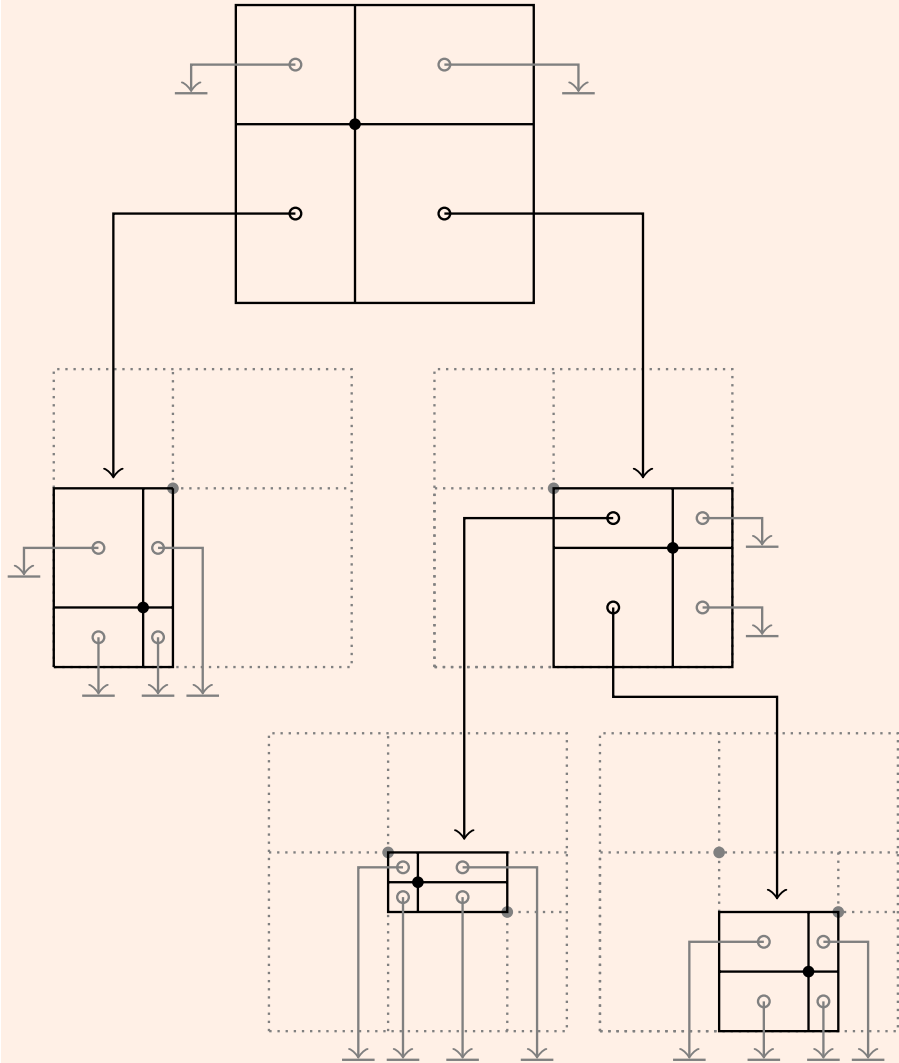

- Each data point **partitions** the data space into 2^k **disjoint regions**.
- In each node, a region points to another node (representing a refined partitioning) or to a special **null** value.
- This data structure is a **point quad tree**.
↗ Finkel and Bentley. Quad Trees: A Data Structure for Retrieval on Composite Keys. *Acta Informatica*, vol. 4, 1974.

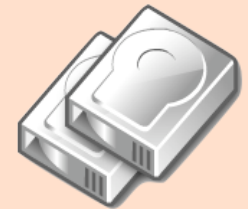

B+-trees...

... over composite keys

Point Quad Trees

Point (Equality) Search
Inserting Data
Region Queries

k-d Trees

Balanced Construction

K-D-B-Trees

K-D-B-Tree Operations
Splitting a Point Page
Splitting a Region Page

R-Trees

Searching and Inserting
Splitting R-Tree Nodes

UB-Trees

Bit Interleaving / Z-Ordering
B+-Trees over Z-Codes
Range Queries

Spaces with High Dimensionality

Wrap-Up

Searching a Point Quad Tree

Point quad tree ($k = 2$)

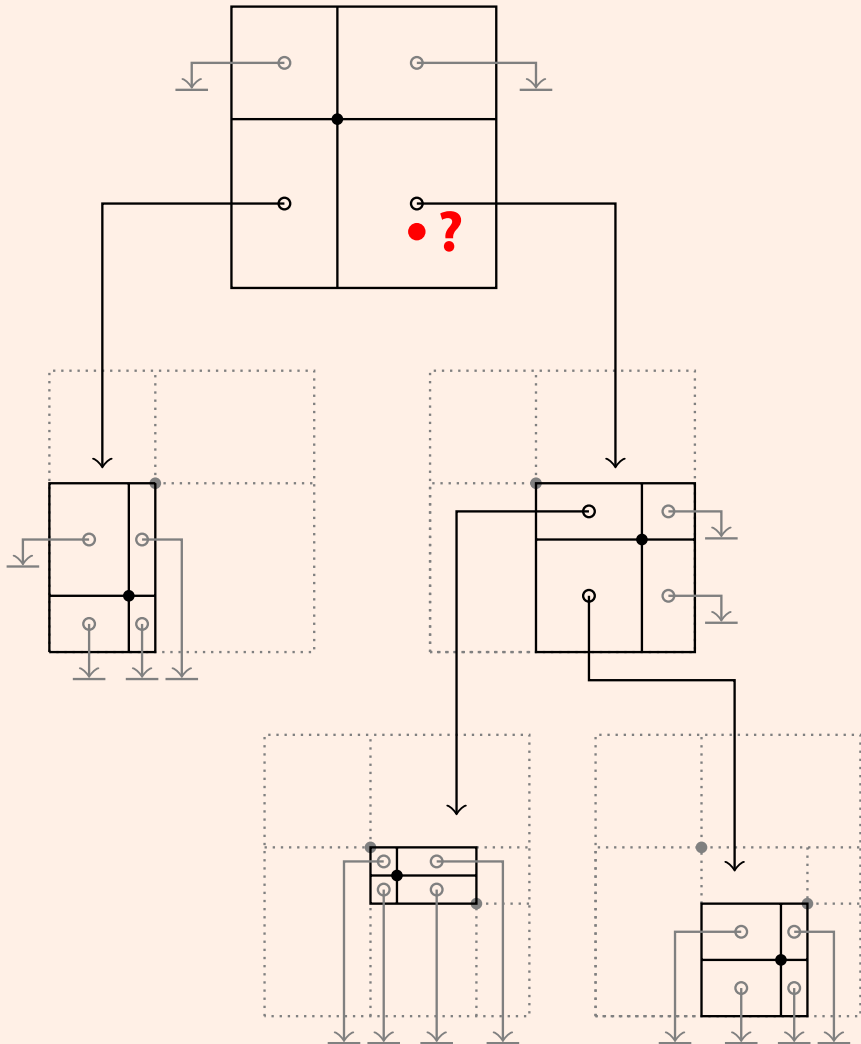

Point quad tree search

```
1 Function: p_search( $q$ ,  $node$ )  
2 if  $q$  matches data point in  $node$  then  
3   | return data point;  
4 else  
5   |  $P \leftarrow$  partition containing  $q$ ;  
6   | if  $P$  points to null then  
7     | return not found;  
8   | else  
9     |  $node' \leftarrow$  node pointed to by  $P$ ;  
10    | return p_search( $q$ ,  $node'$ );
```

```
1 Function: pointsearch( $q$ )  
2 return p_search( $q$ ,  $root$ );
```

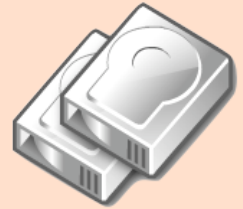

B+-trees...

... over composite keys

Point Quad Trees

Point (Equality) Search

Inserting Data

Region Queries

k-d Trees

Balanced Construction

K-D-B-Trees

K-D-B-Tree Operations

Splitting a Point Page

Splitting a Region Page

R-Trees

Searching and Inserting

Splitting R-Tree Nodes

UB-Trees

Bit Interleaving / Z-Ordering

B+-Trees over Z-Codes

Range Queries

Spaces with High Dimensionality

Wrap-Up

Searching a Point Quad Tree

Point quad tree ($k = 2$)

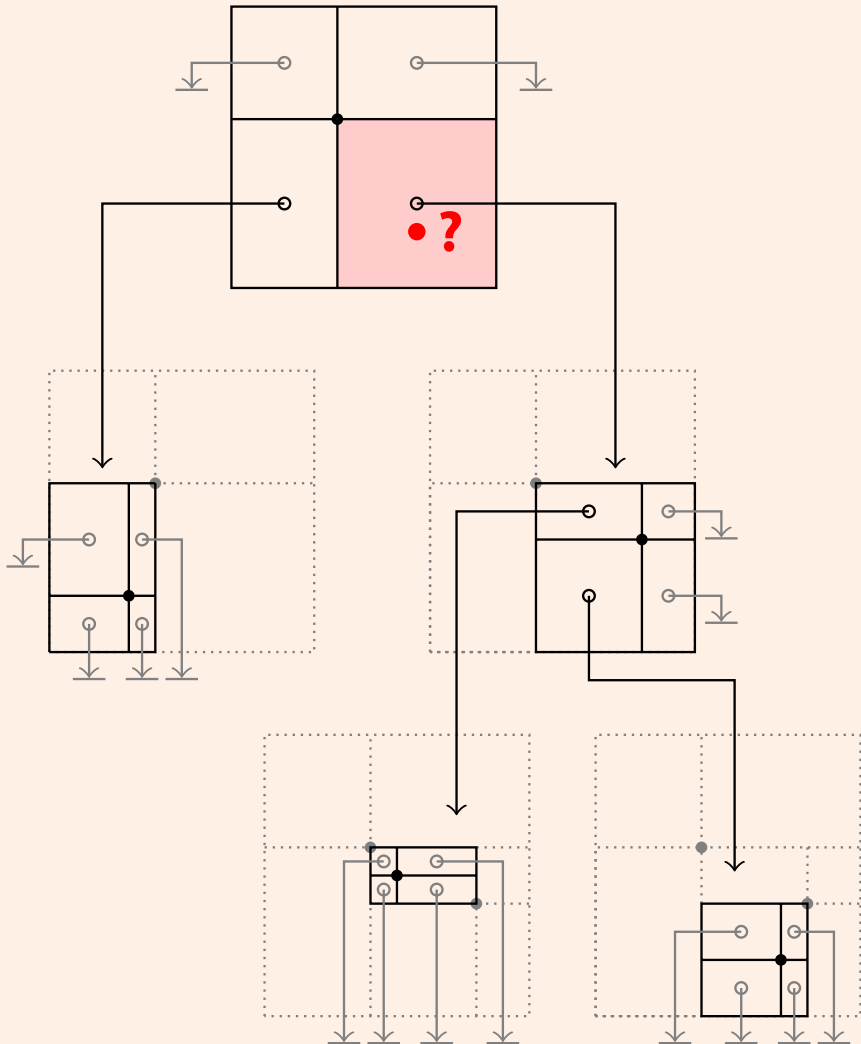

Point quad tree search

```
1 Function: p_search( $q$ ,  $node$ )  
2 if  $q$  matches data point in  $node$  then  
3   | return data point;  
4 else  
5   |  $P \leftarrow$  partition containing  $q$ ;  
6   | if  $P$  points to null then  
7   |   | return not found;  
8   | else  
9   |   |  $node' \leftarrow$  node pointed to by  $P$ ;  
10  |   | return p_search( $q$ ,  $node'$ );
```

```
1 Function: pointsearch( $q$ )  
2 return p_search( $q$ ,  $root$ );
```

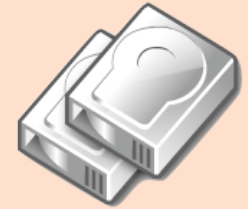

B+-trees...

... over composite keys

Point Quad Trees

Point (Equality) Search

Inserting Data

Region Queries

k-d Trees

Balanced Construction

K-D-B-Trees

K-D-B-Tree Operations

Splitting a Point Page

Splitting a Region Page

R-Trees

Searching and Inserting

Splitting R-Tree Nodes

UB-Trees

Bit Interleaving / Z-Ordering

B+-Trees over Z-Codes

Range Queries

Spaces with High Dimensionality

Wrap-Up

Searching a Point Quad Tree

Point quad tree ($k = 2$)

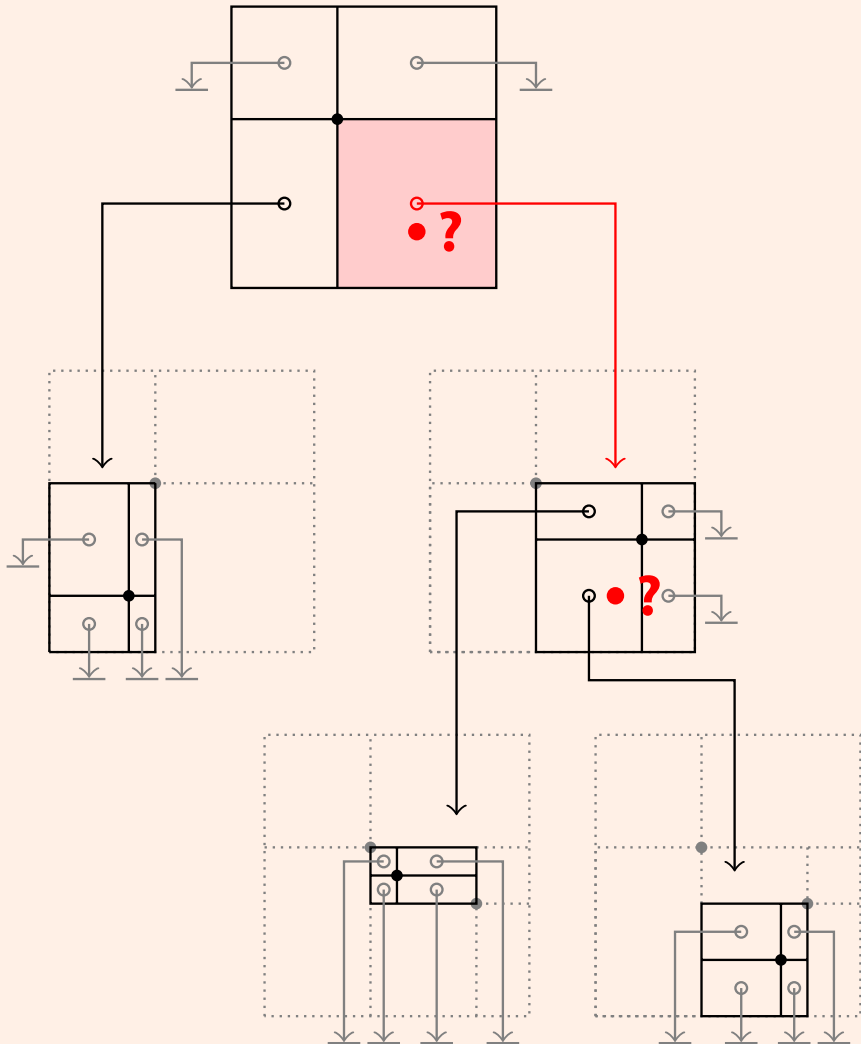

Point quad tree search

```
1 Function: p_search( $q$ ,  $node$ )  
2 if  $q$  matches data point in  $node$  then  
3   | return data point;  
4 else  
5   |  $P \leftarrow$  partition containing  $q$ ;  
6   | if  $P$  points to null then  
7     | return not found;  
8   | else  
9     |  $node' \leftarrow$  node pointed to by  $P$ ;  
10    | return p_search( $q$ ,  $node'$ );
```

```
1 Function: pointsearch( $q$ )  
2 return p_search( $q$ ,  $root$ );
```

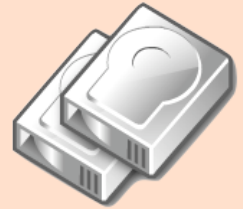

B+-trees...

... over composite keys

Point Quad Trees

Point (Equality) Search

Inserting Data

Region Queries

k-d Trees

Balanced Construction

K-D-B-Trees

K-D-B-Tree Operations

Splitting a Point Page

Splitting a Region Page

R-Trees

Searching and Inserting

Splitting R-Tree Nodes

UB-Trees

Bit Interleaving / Z-Ordering

B+-Trees over Z-Codes

Range Queries

Spaces with High Dimensionality

Wrap-Up

Searching a Point Quad Tree

Point quad tree ($k = 2$)

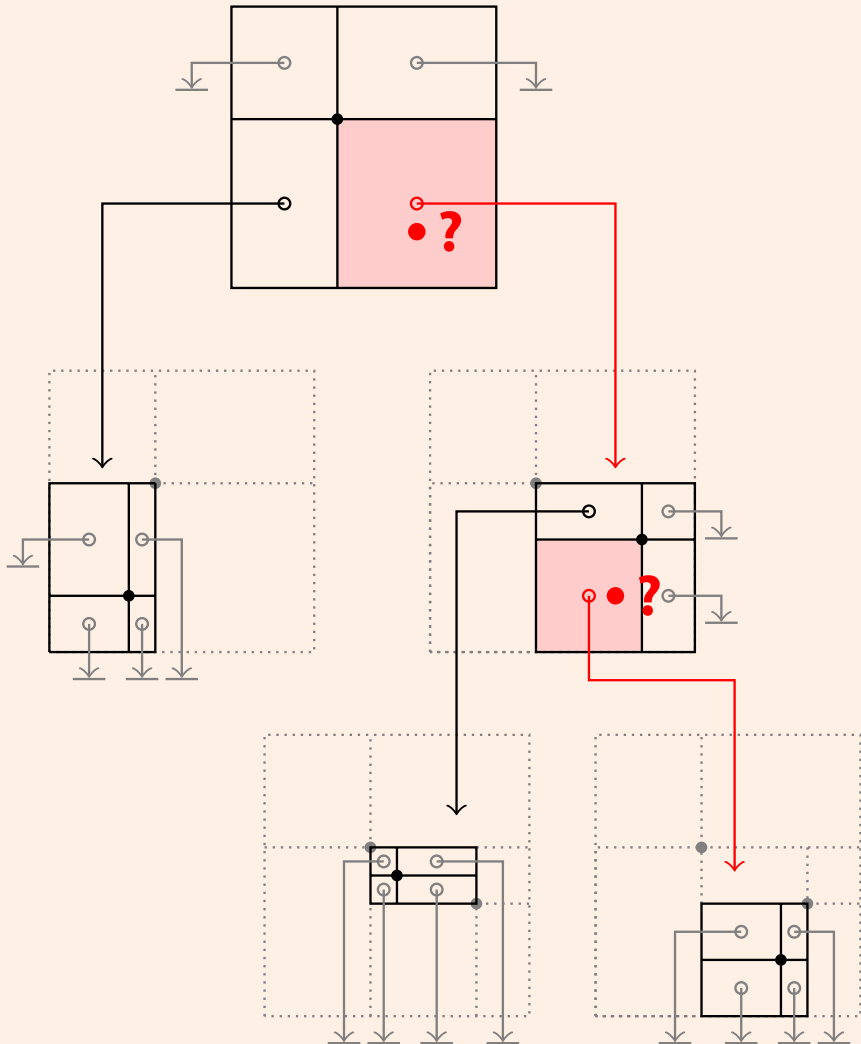

Point quad tree search

```
1 Function: p_search( $q$ ,  $node$ )  
2 if  $q$  matches data point in  $node$  then  
3   | return data point;  
4 else  
5   |  $P \leftarrow$  partition containing  $q$ ;  
6   | if  $P$  points to null then  
7     | return not found;  
8   | else  
9     |  $node' \leftarrow$  node pointed to by  $P$ ;  
10    | return p_search( $q$ ,  $node'$ );
```

```
1 Function: pointsearch( $q$ )  
2 return p_search( $q$ ,  $root$ );
```

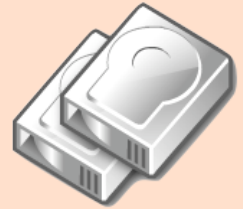

B+-trees...

... over composite keys

Point Quad Trees

Point (Equality) Search

Inserting Data

Region Queries

k-d Trees

Balanced Construction

K-D-B-Trees

K-D-B-Tree Operations

Splitting a Point Page

Splitting a Region Page

R-Trees

Searching and Inserting

Splitting R-Tree Nodes

UB-Trees

Bit Interleaving / Z-Ordering

B+-Trees over Z-Codes

Range Queries

Spaces with High Dimensionality

Wrap-Up

Searching a Point Quad Tree

Point quad tree ($k = 2$)

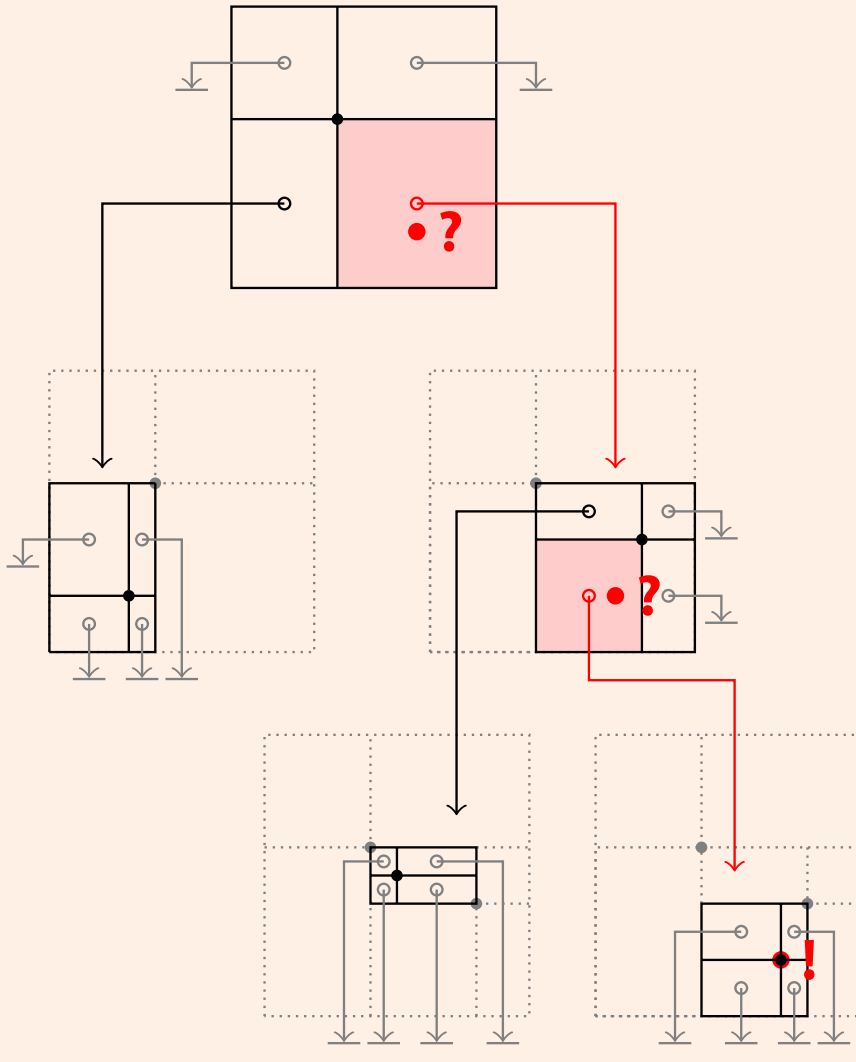

Point quad tree search

```

1 Function: p_search( $q$ ,  $node$ )
2 if  $q$  matches data point in  $node$  then
3   | return data point;
4 else
5   |  $P \leftarrow$  partition containing  $q$ ;
6   | if  $P$  points to null then
7     | return not found;
8   | else
9     |  $node' \leftarrow$  node pointed to by  $P$ ;
10    | return p_search( $q$ ,  $node'$ );

```

```

1 Function: pointsearch( $q$ )
2 return p_search( $q$ ,  $root$ );

```

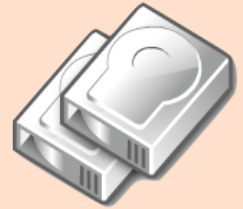

B+-trees...

... over composite keys

Point Quad Trees

Point (Equality) Search

Inserting Data

Region Queries

k-d Trees

Balanced Construction

K-D-B-Trees

K-D-B-Tree Operations

Splitting a Point Page

Splitting a Region Page

R-Trees

Searching and Inserting

Splitting R-Tree Nodes

UB-Trees

Bit Interleaving / Z-Ordering

B+-Trees over Z-Codes

Range Queries

Spaces with High Dimensionality

Wrap-Up

Inserting into a Point Quad Tree

Inserting a point q_{new} into a quad tree happens analogously to an insertion into a binary tree:

- 1 **Traverse** the tree just like during a search for q_{new} until you encounter a partition P with a **null** pointer.
- 2 Create a **new node** n' that spans the same area as P and is partitioned by q_{new} , with all partitions pointing to **null**.
- 3 Let P point to n' .

Note that this procedure does **not** keep the tree **balanced**.

Example (Insertions into an empty point quad tree)

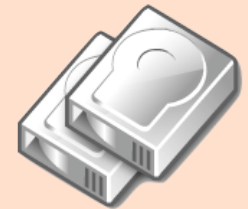
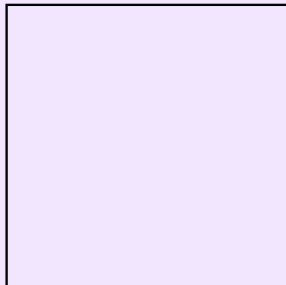

B+-trees...

... over composite keys

Point Quad Trees

Point (Equality) Search

Inserting Data

Region Queries

k-d Trees

Balanced Construction

K-D-B-Trees

K-D-B-Tree Operations

Splitting a Point Page

Splitting a Region Page

R-Trees

Searching and Inserting

Splitting R-Tree Nodes

UB-Trees

Bit Interleaving / Z-Ordering

B+-Trees over Z-Codes

Range Queries

Spaces with High Dimensionality

Wrap-Up

Inserting into a Point Quad Tree

Inserting a point q_{new} into a quad tree happens analogously to an insertion into a binary tree:

- 1 **Traverse** the tree just like during a search for q_{new} until you encounter a partition P with a **null** pointer.
- 2 Create a **new node** n' that spans the same area as P and is partitioned by q_{new} , with all partitions pointing to **null**.
- 3 Let P point to n' .

Note that this procedure does **not** keep the tree **balanced**.

Example (Insertions into an empty point quad tree)

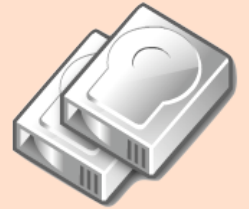
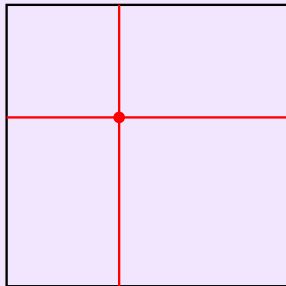

B+-trees...

... over composite keys

Point Quad Trees

Point (Equality) Search

Inserting Data

Region Queries

k-d Trees

Balanced Construction

K-D-B-Trees

K-D-B-Tree Operations

Splitting a Point Page

Splitting a Region Page

R-Trees

Searching and Inserting

Splitting R-Tree Nodes

UB-Trees

Bit Interleaving / Z-Ordering

B+-Trees over Z-Codes

Range Queries

Spaces with High Dimensionality

Wrap-Up

Inserting into a Point Quad Tree

Inserting a point q_{new} into a quad tree happens analogously to an insertion into a binary tree:

- 1 **Traverse** the tree just like during a search for q_{new} until you encounter a partition P with a **null** pointer.
- 2 Create a **new node** n' that spans the same area as P and is partitioned by q_{new} , with all partitions pointing to **null**.
- 3 Let P point to n' .

Note that this procedure does **not** keep the tree **balanced**.

Example (Insertions into an empty point quad tree)

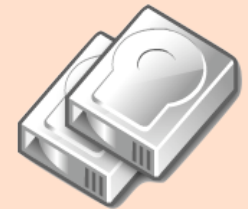
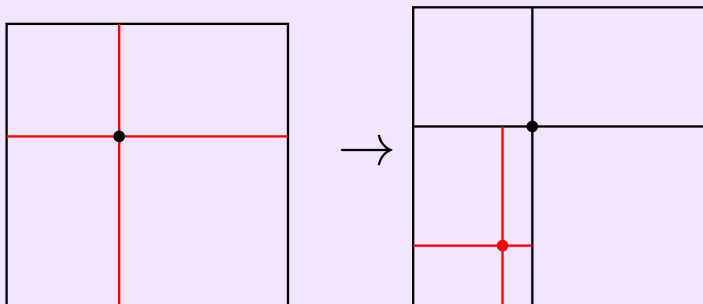

B+-trees...

... over composite keys

Point Quad Trees

Point (Equality) Search

Inserting Data

Region Queries

k-d Trees

Balanced Construction

K-D-B-Trees

K-D-B-Tree Operations

Splitting a Point Page

Splitting a Region Page

R-Trees

Searching and Inserting

Splitting R-Tree Nodes

UB-Trees

Bit Interleaving / Z-Ordering

B+-Trees over Z-Codes

Range Queries

Spaces with High Dimensionality

Wrap-Up

Inserting into a Point Quad Tree

Inserting a point q_{new} into a quad tree happens analogously to an insertion into a binary tree:

- 1 **Traverse** the tree just like during a search for q_{new} until you encounter a partition P with a **null** pointer.
- 2 Create a **new node** n' that spans the same area as P and is partitioned by q_{new} , with all partitions pointing to **null**.
- 3 Let P point to n' .

Note that this procedure does **not** keep the tree **balanced**.

Example (Insertions into an empty point quad tree)

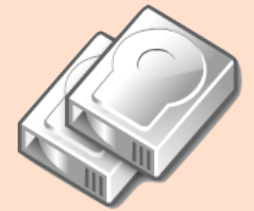
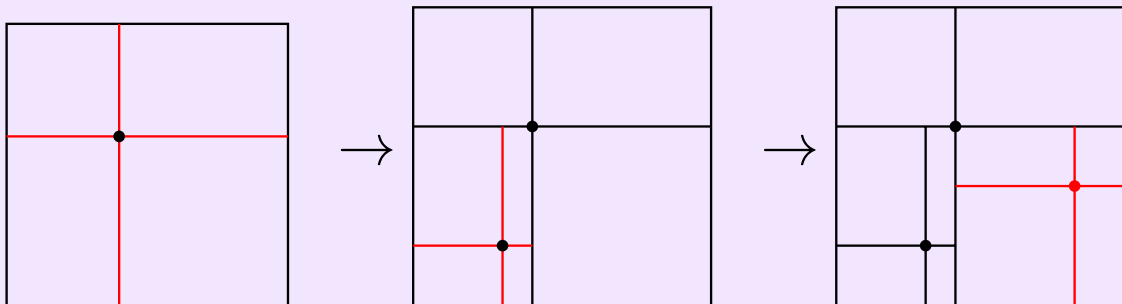

B+-trees...

... over composite keys

Point Quad Trees

Point (Equality) Search

Inserting Data

Region Queries

k-d Trees

Balanced Construction

K-D-B-Trees

K-D-B-Tree Operations

Splitting a Point Page

Splitting a Region Page

R-Trees

Searching and Inserting

Splitting R-Tree Nodes

UB-Trees

Bit Interleaving / Z-Ordering

B+-Trees over Z-Codes

Range Queries

Spaces with High Dimensionality

Wrap-Up

Inserting into a Point Quad Tree

Inserting a point q_{new} into a quad tree happens analogously to an insertion into a binary tree:

- 1 **Traverse** the tree just like during a search for q_{new} until you encounter a partition P with a **null** pointer.
- 2 Create a **new node** n' that spans the same area as P and is partitioned by q_{new} , with all partitions pointing to **null**.
- 3 Let P point to n' .

Note that this procedure does **not** keep the tree **balanced**.

Example (Insertions into an empty point quad tree)

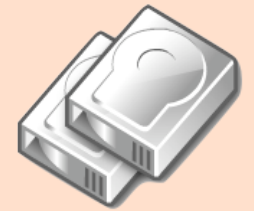
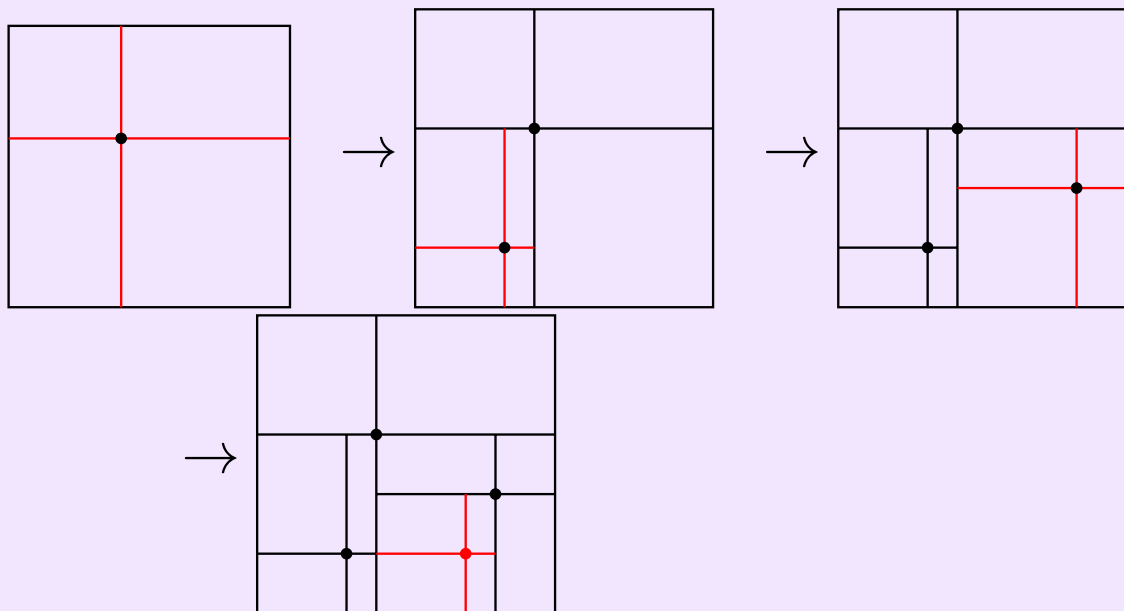

B+-trees...

... over composite keys

Point Quad Trees

Point (Equality) Search

Inserting Data

Region Queries

k-d Trees

Balanced Construction

K-D-B-Trees

K-D-B-Tree Operations

Splitting a Point Page

Splitting a Region Page

R-Trees

Searching and Inserting

Splitting R-Tree Nodes

UB-Trees

Bit Interleaving / Z-Ordering

B+-Trees over Z-Codes

Range Queries

Spaces with High Dimensionality

Wrap-Up

Inserting into a Point Quad Tree

Inserting a point q_{new} into a quad tree happens analogously to an insertion into a binary tree:

- 1 **Traverse** the tree just like during a search for q_{new} until you encounter a partition P with a **null** pointer.
- 2 Create a **new node** n' that spans the same area as P and is partitioned by q_{new} , with all partitions pointing to **null**.
- 3 Let P point to n' .

Note that this procedure does **not** keep the tree **balanced**.

Example (Insertions into an empty point quad tree)

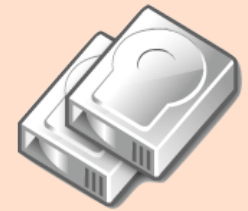
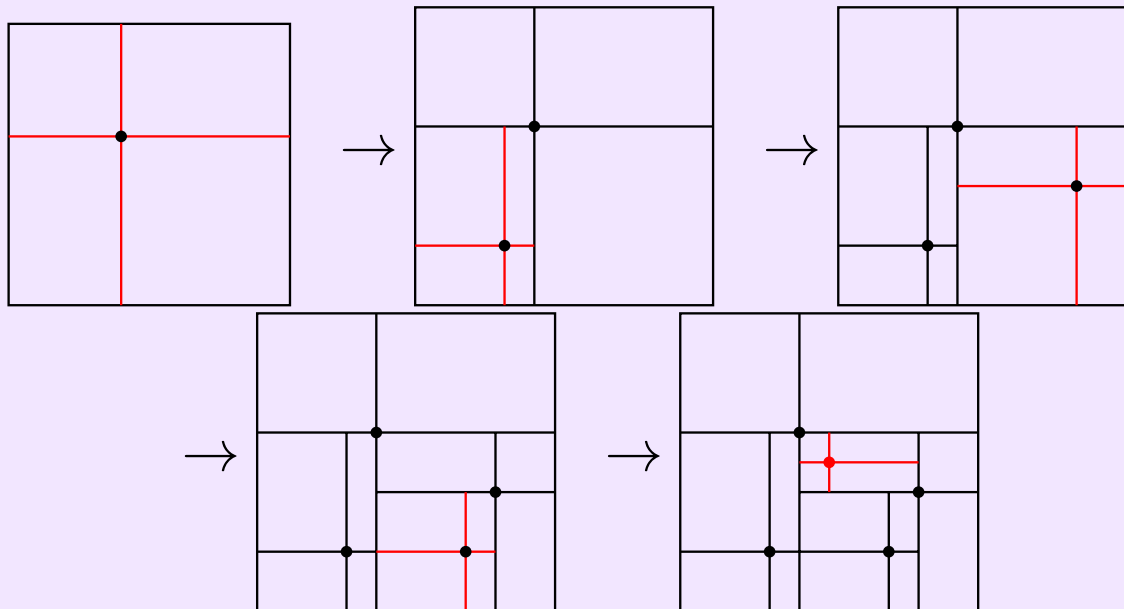

B+-trees...

... over composite keys

Point Quad Trees

Point (Equality) Search

Inserting Data

Region Queries

k-d Trees

Balanced Construction

K-D-B-Trees

K-D-B-Tree Operations

Splitting a Point Page

Splitting a Region Page

R-Trees

Searching and Inserting

Splitting R-Tree Nodes

UB-Trees

Bit Interleaving / Z-Ordering

B+-Trees over Z-Codes

Range Queries

Spaces with High Dimensionality

Wrap-Up

Range Queries

To evaluate a **range query**², we may need to follow **several** children of a quad tree node *node*:

Point quad tree range search

```
1 Function: r_search (Q, node)
2 if data point in node is in Q then
3   | append data point to result ;
4 foreach partition P in node that intersects with Q do
5   | node' ← node pointed to by P ;
6   | r_search (Q, node') ;
```

```
1 Function: regionsearch (Q)
2 return r_search (Q, root) ;
```

²We consider **rectangular** regions only; other shapes may be answered by querying for the **bounding rectangle** and post-processing the output.

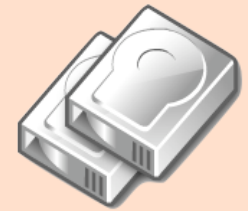

B+-trees...

... over composite keys

Point Quad Trees

Point (Equality) Search

Inserting Data

Region Queries

k-d Trees

Balanced Construction

K-D-B-Trees

K-D-B-Tree Operations

Splitting a Point Page

Splitting a Region Page

R-Trees

Searching and Inserting

Splitting R-Tree Nodes

UB-Trees

Bit Interleaving / Z-Ordering

B+-Trees over Z-Codes

Range Queries

Spaces with High Dimensionality

Wrap-Up

Point Quad Trees—Discussion

Point quad trees

- ✓ are **symmetric** with respect to all dimensions and
- ✓ can answer **point queries** and **region queries**.

But

- ✗ the shape of a quad tree depends on the **insertion order** of its content, in the worst case **degenerates** into a **linked list**,
- ✗ **null** pointers are **space inefficient** (particularly for large k).

In addition,

- they can only store **point data**.

Also remember that quad trees were designed for **main memory** operation.

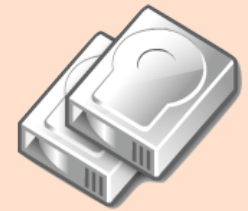

B+-trees...

... over composite keys

Point Quad Trees

Point (Equality) Search

Inserting Data

Region Queries

k-d Trees

Balanced Construction

K-D-B-Trees

K-D-B-Tree Operations

Splitting a Point Page

Splitting a Region Page

R-Trees

Searching and Inserting

Splitting R-Tree Nodes

UB-Trees

Bit Interleaving / Z-Ordering

B+-Trees over Z-Codes

Range Queries

Spaces with High Dimensionality

Wrap-Up

k-d Trees

Sample k -d tree ($k = 2$)

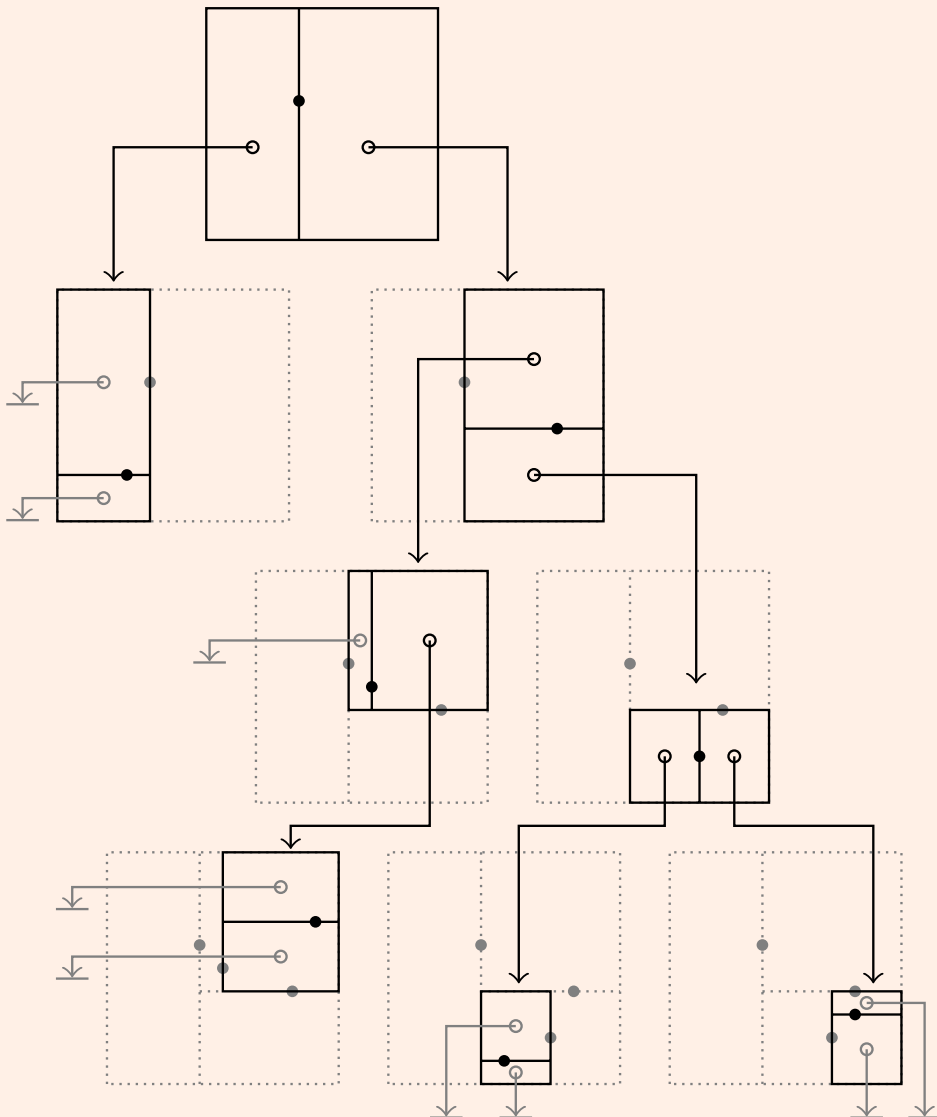

- Index k -dimensional data, but keep the tree **binary**.
- For each **tree level** l use a different **discriminator dimension** d_l along which to **partition**.
 - Typically: **round robin**
- This is a **k -d tree**.
 - ↗ Bentley. Multidimensional Binary Search Trees Used for Associative Searching. *Comm. ACM*, vol. 18, no. 9, Sept. 1975.

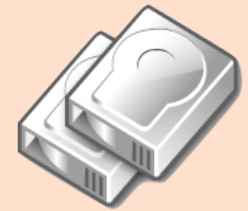

B+-trees...

... over composite keys

Point Quad Trees

Point (Equality) Search

Inserting Data

Region Queries

k-d Trees

Balanced Construction

K-D-B-Trees

K-D-B-Tree Operations

Splitting a Point Page

Splitting a Region Page

R-Trees

Searching and Inserting

Splitting R-Tree Nodes

UB-Trees

Bit Interleaving / Z-Ordering

B+-Trees over Z-Codes

Range Queries

Spaces with High Dimensionality

Wrap-Up

k-d Trees

k-d trees inherit the positive properties of the point quad trees, but improve on **space efficiency**.

For a given point set, we can also construct a **balanced** k-d tree:³

k-d tree construction (Bentley's OPTIMIZE algorithm)

```
1 Function: kdtree (pointset, level)
2 if pointset is empty then
3   return null ;
4 else
5    $p \leftarrow$  median from pointset (along  $d_{level}$ ) ;
6    $points_{left} \leftarrow \{v \in pointset \text{ where } v_{d_{level}} < p_{d_{level}}\}$ ;
7    $points_{right} \leftarrow \{v \in pointset \text{ where } v_{d_{level}} \geq p_{d_{level}}\}$ ;
8    $n \leftarrow$  new k-d tree node, with data point  $p$  ;
9    $n.left \leftarrow$  kdtree ( $points_{left}$ ,  $level + 1$ ) ;
10   $n.right \leftarrow$  kdtree ( $points_{right}$ ,  $level + 1$ ) ;
11  return  $n$  ;
```

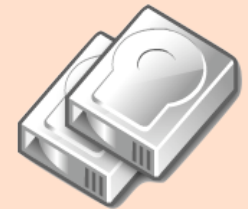

B+-trees...

... over composite keys

Point Quad Trees

Point (Equality) Search

Inserting Data

Region Queries

k-d Trees

Balanced Construction

K-D-B-Trees

K-D-B-Tree Operations

Splitting a Point Page

Splitting a Region Page

R-Trees

Searching and Inserting

Splitting R-Tree Nodes

UB-Trees

Bit Interleaving / Z-Ordering

B+-Trees over Z-Codes

Range Queries

Spaces with High Dimensionality

Wrap-Up

³ v_i : coordinate i of point v .

Balanced k -d Tree Construction

Example (Step-by-step balanced k -d tree construction)

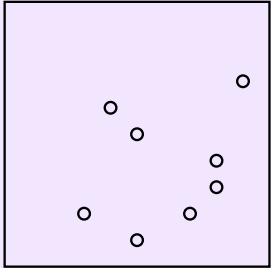

Multi-Dimensional Indexing

Torsten Grust

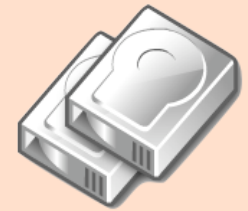

B+-trees...

... over composite keys

Point Quad Trees

Point (Equality) Search

Inserting Data

Region Queries

k-d Trees

Balanced Construction

K-D-B-Trees

K-D-B-Tree Operations

Splitting a Point Page

Splitting a Region Page

R-Trees

Searching and Inserting

Splitting R-Tree Nodes

UB-Trees

Bit Interleaving / Z-Ordering

B+-Trees over Z-Codes

Range Queries

Spaces with High Dimensionality

Wrap-Up

Balanced k -d Tree Construction

Multi-Dimensional
Indexing

Torsten Grust

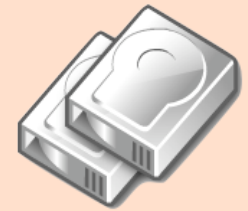

Example (Step-by-step balanced k -d tree construction)

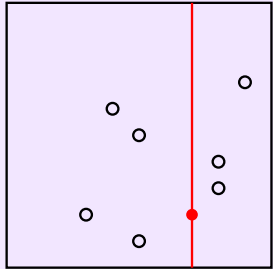

B+-trees...

... over composite keys

Point Quad Trees

Point (Equality) Search

Inserting Data

Region Queries

k-d Trees

Balanced Construction

K-D-B-Trees

K-D-B-Tree Operations

Splitting a Point Page

Splitting a Region Page

R-Trees

Searching and Inserting

Splitting R-Tree Nodes

UB-Trees

Bit Interleaving / Z-Ordering

B+-Trees over Z-Codes

Range Queries

Spaces with High Dimensionality

Wrap-Up

Balanced k -d Tree Construction

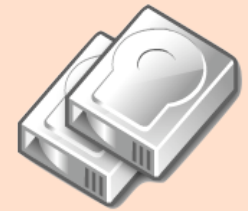

Example (Step-by-step balanced k -d tree construction)

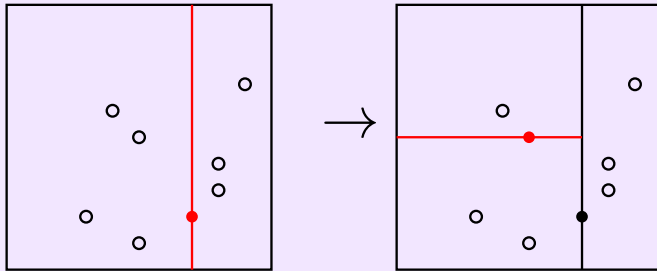

B+-trees...

... over composite keys

Point Quad Trees

Point (Equality) Search

Inserting Data

Region Queries

k -d Trees

Balanced Construction

K-D-B-Trees

K-D-B-Tree Operations

Splitting a Point Page

Splitting a Region Page

R-Trees

Searching and Inserting

Splitting R-Tree Nodes

UB-Trees

Bit Interleaving / Z-Ordering

B+-Trees over Z-Codes

Range Queries

Spaces with High Dimensionality

Wrap-Up

Balanced k -d Tree Construction

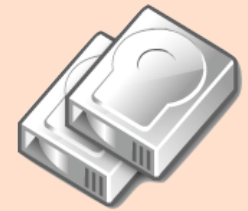

Example (Step-by-step balanced k -d tree construction)

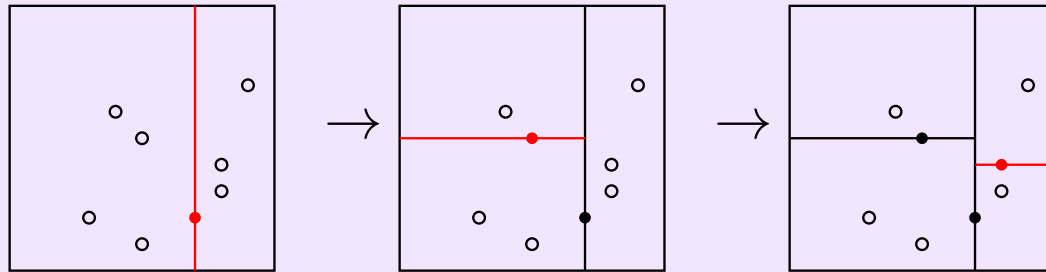

B+-trees...

... over composite keys

Point Quad Trees

Point (Equality) Search

Inserting Data

Region Queries

k -d Trees

Balanced Construction

K-D-B-Trees

K-D-B-Tree Operations

Splitting a Point Page

Splitting a Region Page

R-Trees

Searching and Inserting

Splitting R-Tree Nodes

UB-Trees

Bit Interleaving / Z-Ordering

B+-Trees over Z-Codes

Range Queries

Spaces with High Dimensionality

Wrap-Up

Balanced k -d Tree Construction

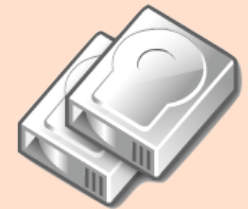

Example (Step-by-step balanced k -d tree construction)

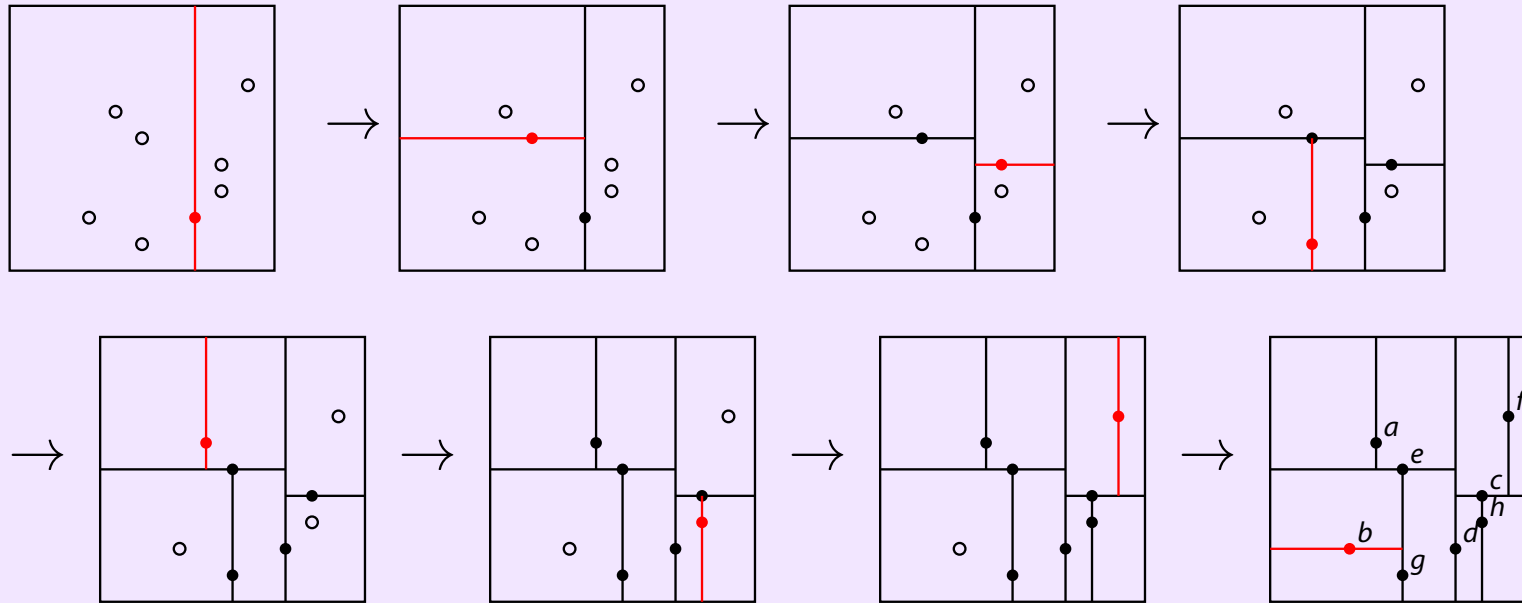

B+-trees...

... over composite keys

Point Quad Trees

Point (Equality) Search
Inserting Data
Region Queries

k -d Trees

Balanced Construction

K-D-B-Trees

K-D-B-Tree Operations
Splitting a Point Page
Splitting a Region Page

R-Trees

Searching and Inserting
Splitting R-Tree Nodes

UB-Trees

Bit Interleaving / Z-Ordering
B+-Trees over Z-Codes
Range Queries

Spaces with High Dimensionality

Wrap-Up

Balanced k -d Tree Construction

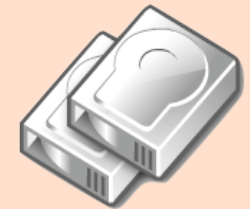

Example (Step-by-step balanced k -d tree construction)

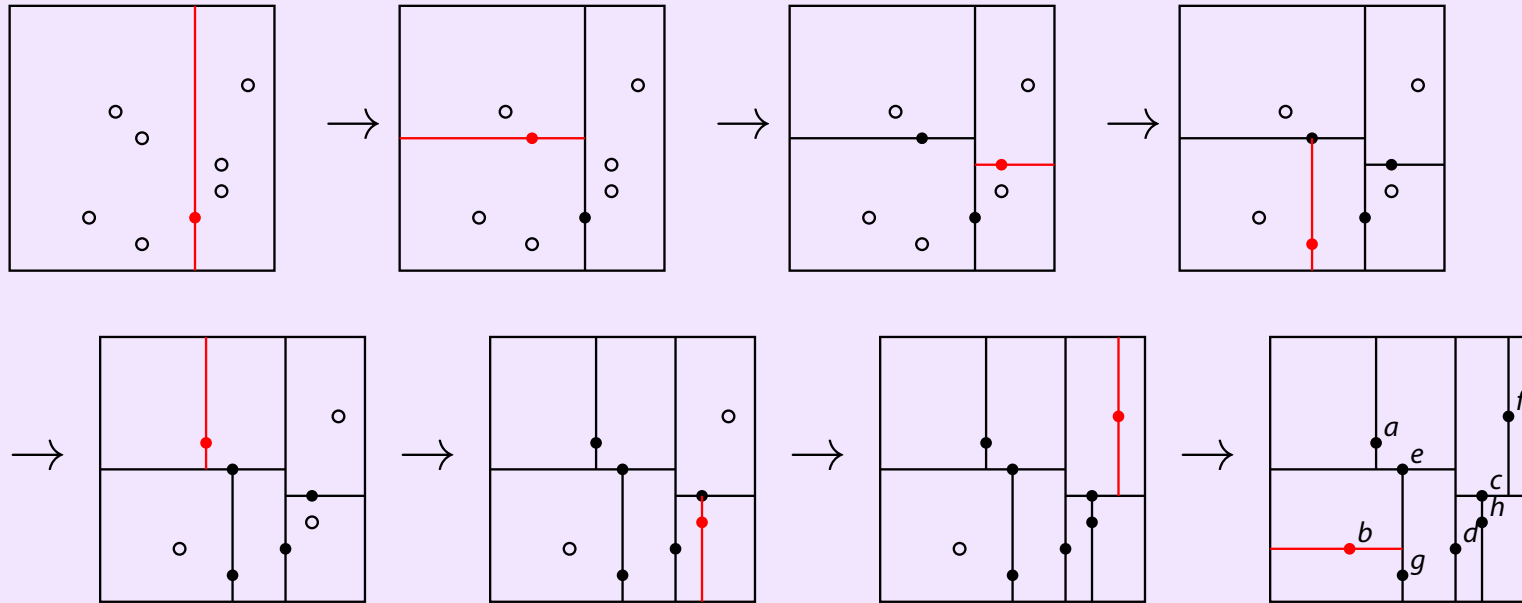

Resulting tree shape:

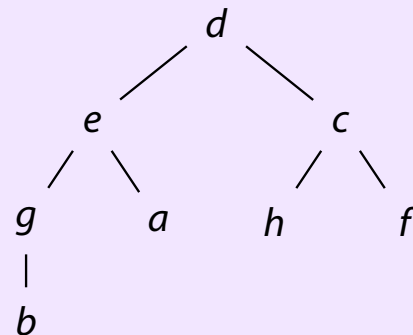

B+-trees...

... over composite keys

Point Quad Trees

Point (Equality) Search

Inserting Data

Region Queries

k -d Trees

Balanced Construction

K-D-B-Trees

K-D-B-Tree Operations

Splitting a Point Page

Splitting a Region Page

R-Trees

Searching and Inserting

Splitting R-Tree Nodes

UB-Trees

Bit Interleaving / Z-Ordering

B+-Trees over Z-Codes

Range Queries

Spaces with High Dimensionality

Wrap-Up

K-D-B-Trees

k -d trees improve on some of the deficiencies of point quad trees:

- ✓ We can **balance** a k -d tree by **re-building** it.
(For a limited number of points and in-memory processing, this may be sufficient.)
- ✓ We're no longer wasting big amounts of **space**.

It's time to bring k -d trees to the disk. The **K-D-B-Tree**

- uses **pages** as an organizational unit
(*e.g.*, each node in the K-D-B-tree fills a page) and
- uses a **k -d tree-like layout** to organize each page.

↗ John T. Robinsion. The K-D-B-Tree: A Search Structure for Large Multidimensional Dynamic Indexes. *SIGMOD 1981*.

Multi-Dimensional Indexing

Torsten Grust

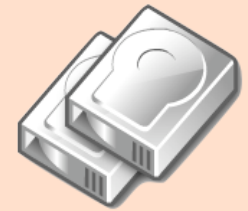

B+-trees...

... over composite keys

Point Quad Trees

Point (Equality) Search
Inserting Data
Region Queries

k -d Trees

Balanced Construction

K-D-B-Trees

K-D-B-Tree Operations
Splitting a Point Page
Splitting a Region Page

R-Trees

Searching and Inserting
Splitting R-Tree Nodes

UB-Trees

Bit Interleaving / Z-Ordering
B+-Trees over Z-Codes
Range Queries

Spaces with High Dimensionality

Wrap-Up

K-D-B-Tree Idea

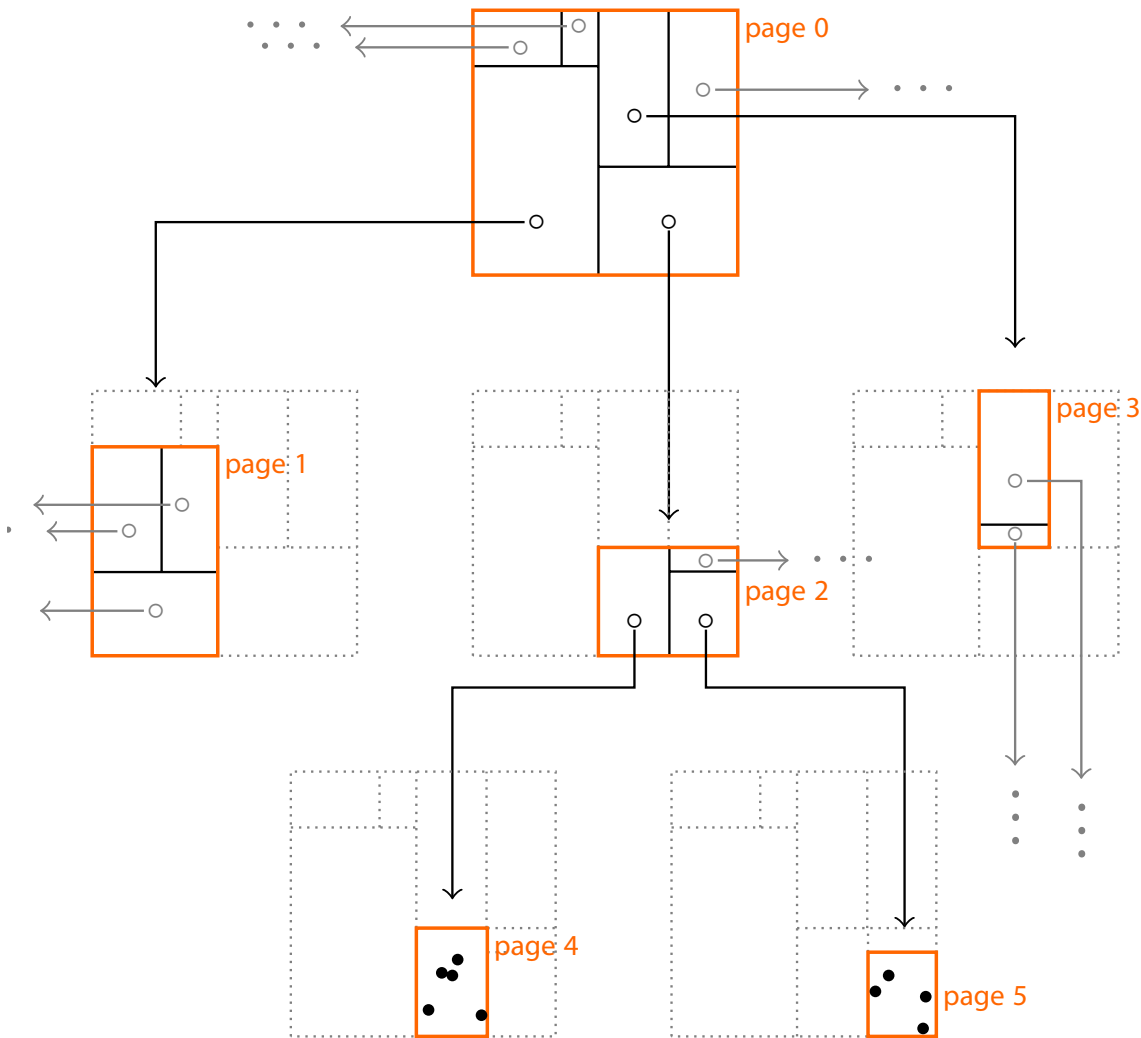

Region pages:

- contain entries $\langle \text{region}, \text{pageID} \rangle$
- no **null** pointers
- form a **balanced** tree
- all regions **disjoint** and **rectangular**

Point pages:

- contain entries $\langle \text{point}, \text{rid} \rangle$
- \rightsquigarrow B⁺-tree leaf nodes

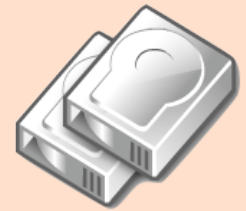

B⁺-trees...

... over composite keys

Point Quad Trees

Point (Equality) Search

Inserting Data

Region Queries

k-d Trees

Balanced Construction

K-D-B-Trees

K-D-B-Tree Operations

Splitting a Point Page

Splitting a Region Page

R-Trees

Searching and Inserting

Splitting R-Tree Nodes

UB-Trees

Bit Interleaving / Z-Ordering

B⁺-Trees over Z-Codes

Range Queries

Spaces with High Dimensionality

Wrap-Up

K-D-B-Tree Operations

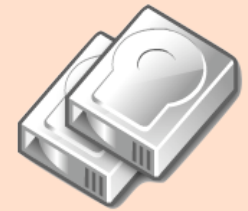

B+-trees...

... over composite keys

Point Quad Trees

Point (Equality) Search

Inserting Data

Region Queries

k-d Trees

Balanced Construction

K-D-B-Trees

K-D-B-Tree Operations

Splitting a Point Page

Splitting a Region Page

R-Trees

Searching and Inserting

Splitting R-Tree Nodes

UB-Trees

Bit Interleaving / Z-Ordering

B+-Trees over Z-Codes

Range Queries

Spaces with High Dimensionality

Wrap-Up

- **Searching** a K-D-B-Tree works straightforwardly:
 - Within each page determine all regions R_i that contain the query point q (intersect with the query region Q).
 - For each of the R_i , consult the page it points to and recurse.
 - On point pages, fetch and return the corresponding record for each matching data point p_i .
- When **inserting** data, we keep the K-D-B-Tree **balanced**, much like we did in the **B⁺-tree**:
 - Simply insert a $\langle region, pageID \rangle$ ($\langle point, rid \rangle$) entry into a region page (point page) if there's **sufficient space**.
 - **Otherwise, split** the page.

K-D-B-Tree: Splitting a Point Page

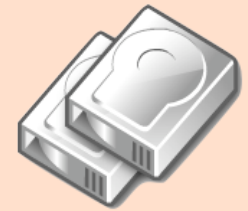

Splitting a point page p

- 1 **Choose a dimension** i and an i -coordinate x_i along which to split, such that the split will result in two pages that are not overfull.
- 2 **Move** data points p with $p_i < x_i$ and $p_i \geq x_i$ to new pages p_{left} and p_{right} (respectively).
- 3 Replace $\langle \text{region}, p \rangle$ in the **parent** of p with $\langle \text{left region}, p_{\text{left}} \rangle$ and $\langle \text{right region}, p_{\text{right}} \rangle$.

Step 3 may cause an **overflow** in p 's parent and, hence, lead to a **split** of a **region page**.

B+-trees...

... over composite keys

Point Quad Trees

Point (Equality) Search

Inserting Data

Region Queries

k-d Trees

Balanced Construction

K-D-B-Trees

K-D-B-Tree Operations

Splitting a Point Page

Splitting a Region Page

R-Trees

Searching and Inserting

Splitting R-Tree Nodes

UB-Trees

Bit Interleaving / Z-Ordering

B+-Trees over Z-Codes

Range Queries

Spaces with High Dimensionality

Wrap-Up

K-D-B-Tree: Splitting a Region Page

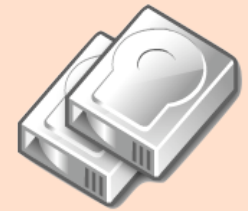

B+-trees...

... over composite keys

Point Quad Trees

Point (Equality) Search
Inserting Data
Region Queries

k-d Trees

Balanced Construction

K-D-B-Trees

K-D-B-Tree Operations
Splitting a Point Page

Splitting a Region Page

R-Trees

Searching and Inserting
Splitting R-Tree Nodes

UB-Trees

Bit Interleaving / Z-Ordering
B+-Trees over Z-Codes
Range Queries

Spaces with High Dimensionality

Wrap-Up

- Splitting a **point page** and moving its data **points** to the resulting pages is straightforward.
- In case of a **region page split**, by contrast, some **regions** may intersect with **both** sides of the split.

Consider, *e.g.*, page 0 on slide 19:

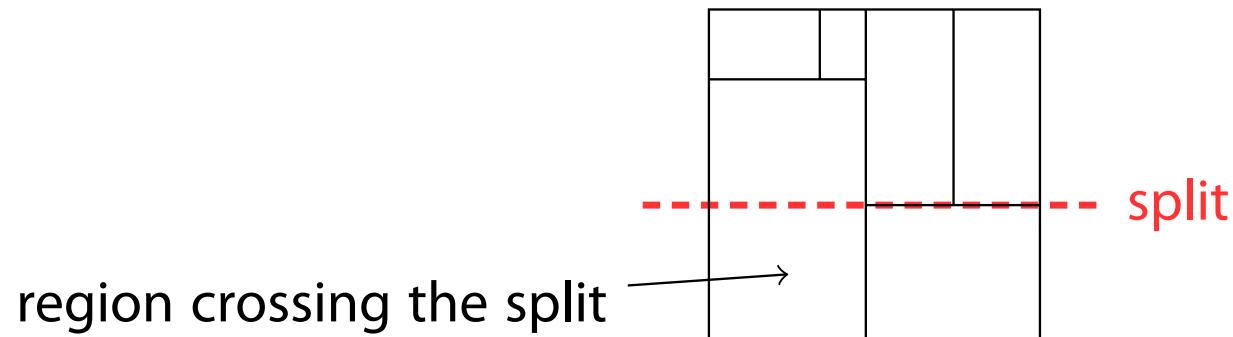

- Such regions need to be **split**, too.
- This can cause a **recursive** splitting **downward** (!) the tree.

Example: Page 0 Split in K-D-B-Tree of slide 19

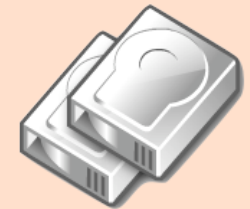

Split of region page 0

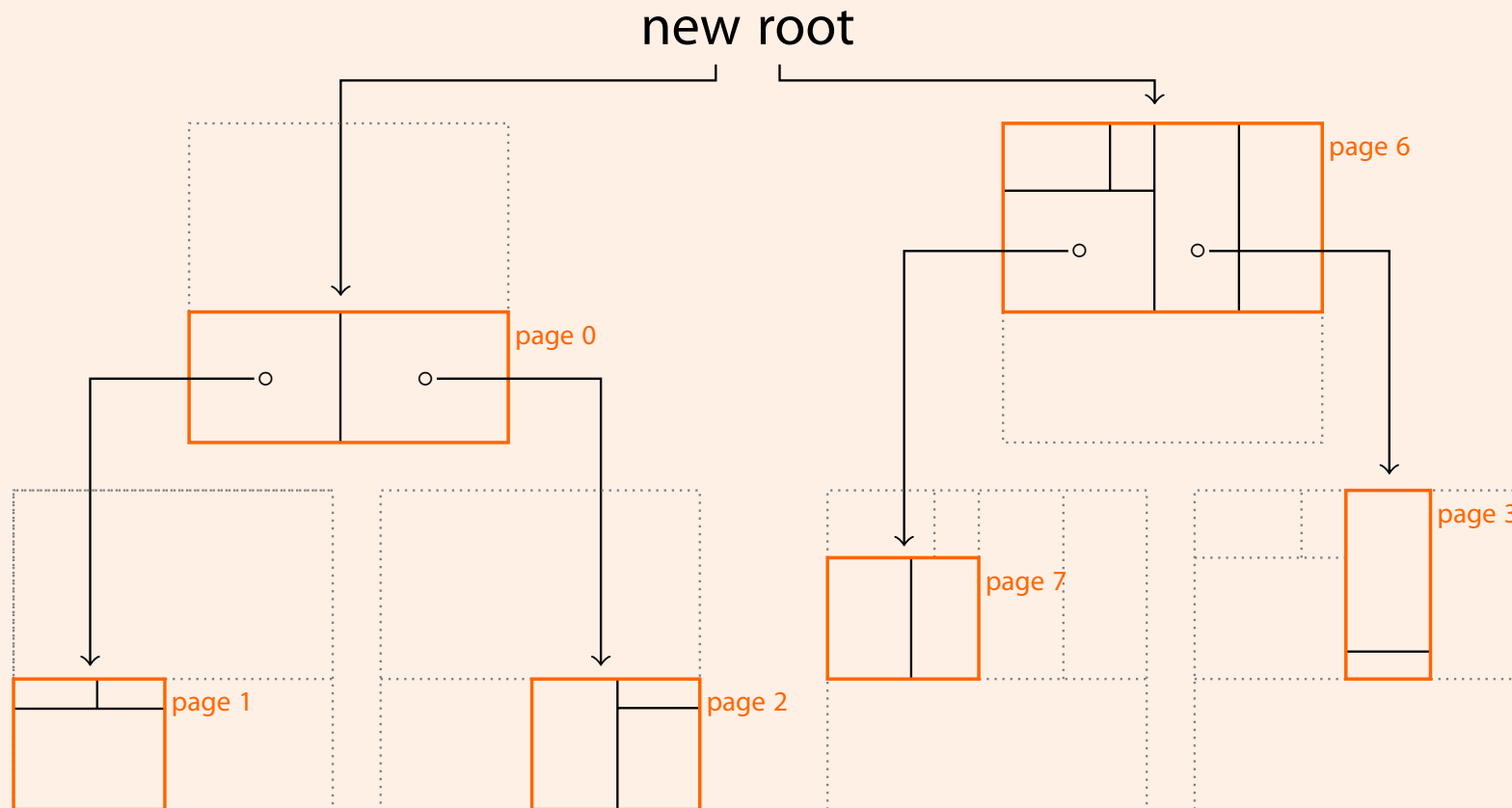

B+-trees...

... over composite keys

Point Quad Trees

Point (Equality) Search
Inserting Data
Region Queries

k-d Trees

Balanced Construction

K-D-B-Trees

K-D-B-Tree Operations
Splitting a Point Page
Splitting a Region Page

R-Trees

Searching and Inserting
Splitting R-Tree Nodes

UB-Trees

Bit Interleaving / Z-Ordering
B+-Trees over Z-Codes
Range Queries

Spaces with High Dimensionality

Wrap-Up

- Root page 0 \Rightarrow pages 0 and 6 (\leadsto creation of new root).
- Region page 1 \Rightarrow pages 1 and 7 (point pages not shown).

K-D-B-Trees: Discussion

K-D-B-Trees

- ✓ are **symmetric** with respect to all dimensions,
- ✓ **cluster** data in a space-aware and page-oriented fashion,
- ✓ are **dynamic** with respect to updates, and
- ✓ can answer **point queries** and **region queries**.

However,

- we still don't have support for **region data** and
- K-D-B-Trees (like *k-d* trees) will not handle **deletes** dynamically.

This is because we always partitioned the data space such that

- every region is **rectangular** and
- regions never **intersect**.

Multi-Dimensional Indexing

Torsten Grust

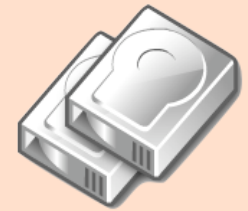

B+-trees...

... over composite keys

Point Quad Trees

Point (Equality) Search

Inserting Data

Region Queries

k-d Trees

Balanced Construction

K-D-B-Trees

K-D-B-Tree Operations

Splitting a Point Page

Splitting a Region Page

R-Trees

Searching and Inserting

Splitting R-Tree Nodes

UB-Trees

Bit Interleaving / Z-Ordering

B+-Trees over Z-Codes

Range Queries

Spaces with High Dimensionality

Wrap-Up

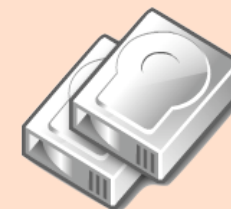

R-trees do not have the disjointness requirement:

- R-tree inner or leaf nodes contain $\langle region, pageID \rangle$ or $\langle region, rid \rangle$ entries (respectively).
region is the **minimum bounding rectangle** that spans all data items reachable by the respective pointer.
- Every node contains between d and $2d$ entries (\rightsquigarrow B⁺-tree).⁴
- **Insertion** and **deletion** algorithms keep an R-tree **balanced** at all times.

B+-trees...

... over composite keys

Point Quad Trees

Point (Equality) Search
Inserting Data
Region Queries

k-d Trees

Balanced Construction

K-D-B-Trees

K-D-B-Tree Operations
Splitting a Point Page
Splitting a Region Page

R-Trees

Searching and Inserting
Splitting R-Tree Nodes

UB-Trees

Bit Interleaving / Z-Ordering
B+-Trees over Z-Codes
Range Queries

Spaces with High Dimensionality

Wrap-Up

R-trees allow the storage of **point and region data**.

↗ Antonin Guttman. R-Trees: A Dynamic Index Structure for Spatial Searching. *SIGMOD 1984*.

⁴except the root node

R-Tree: Example

- order: $d = 2$
- region data

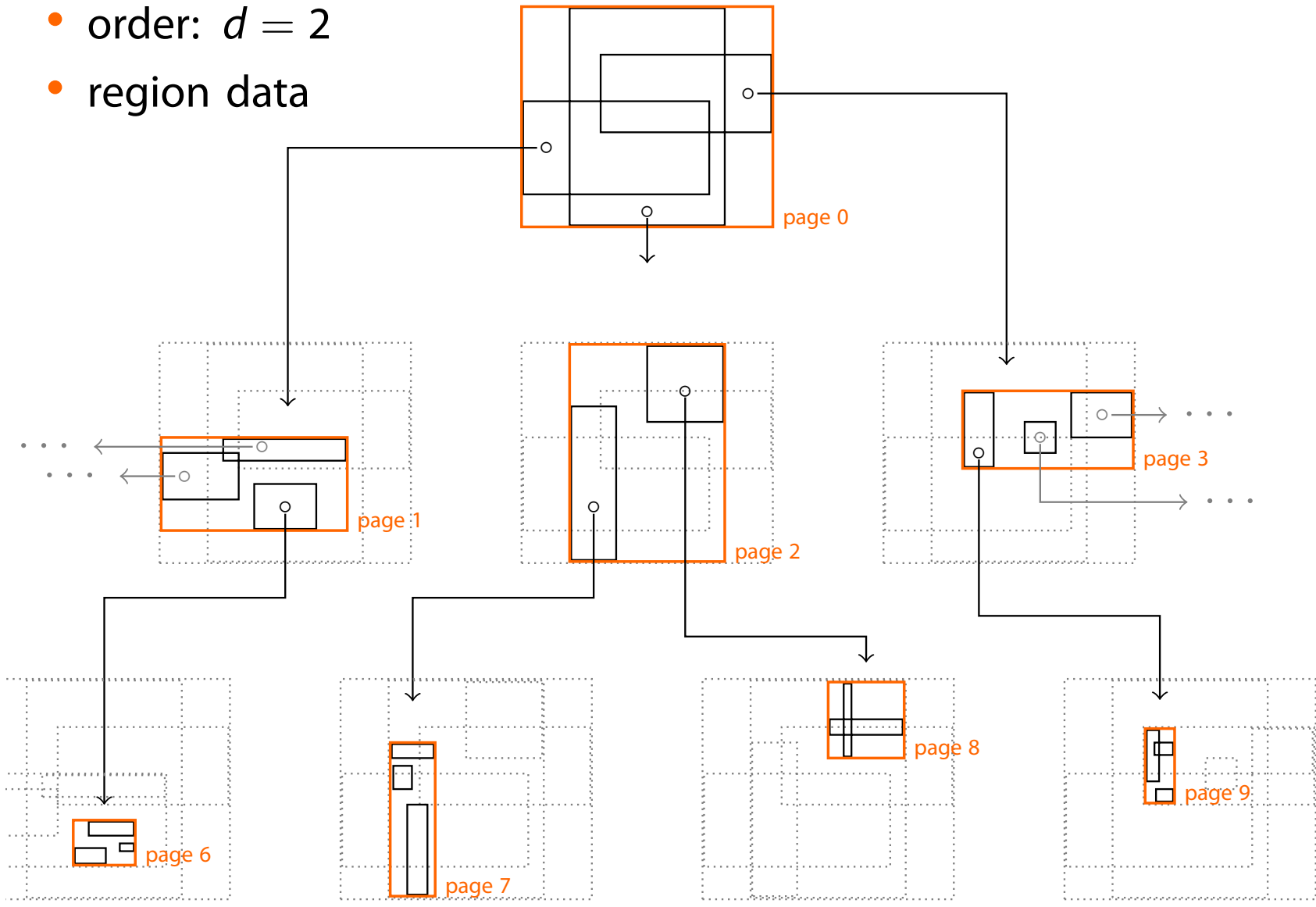

inner nodes

leaf nodes

Multi-Dimensional Indexing

Torsten Grust

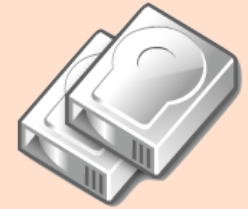

B+-trees...

... over composite keys

Point Quad Trees

Point (Equality) Search
Inserting Data
Region Queries

k-d Trees

Balanced Construction

K-D-B-Trees

K-D-B-Tree Operations
Splitting a Point Page
Splitting a Region Page

R-Trees

Searching and Inserting
Splitting R-Tree Nodes

UB-Trees

Bit Interleaving / Z-Ordering
B+-Trees over Z-Codes
Range Queries

Spaces with High Dimensionality

Wrap-Up

R-Tree: Searching and Inserting

While **searching** an R-tree, we may have to descend into more than one child node for point **and** region queries (↗ range search in point quad trees, slide 13).

Inserting into an R-tree (cf. B⁺-tree insertion)

- 1 **Choose** a leaf node n to insert the new entry.
 - Try to minimize the necessary region enlargement(s).
- 2 If n is **full**, **split** it (resulting in n and n') and distribute old and new entries evenly across n and n' .
 - Splits may propagate bottom-up and eventually reach the root (↗ B⁺-tree).
- 3 After the insertion, some regions in the ancestor nodes of n may need to be **adjusted** to cover the new entry.

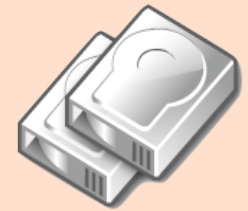

B⁺-trees...

... over composite keys

Point Quad Trees

Point (Equality) Search

Inserting Data

Region Queries

k-d Trees

Balanced Construction

K-D-B-Trees

K-D-B-Tree Operations

Splitting a Point Page

Splitting a Region Page

R-Trees

Searching and Inserting

Splitting R-Tree Nodes

UB-Trees

Bit Interleaving / Z-Ordering

B⁺-Trees over Z-Codes

Range Queries

Spaces with High Dimensionality

Wrap-Up

Splitting an R-Tree Node

To **split** an R-tree node, we generally have more than one alternative:

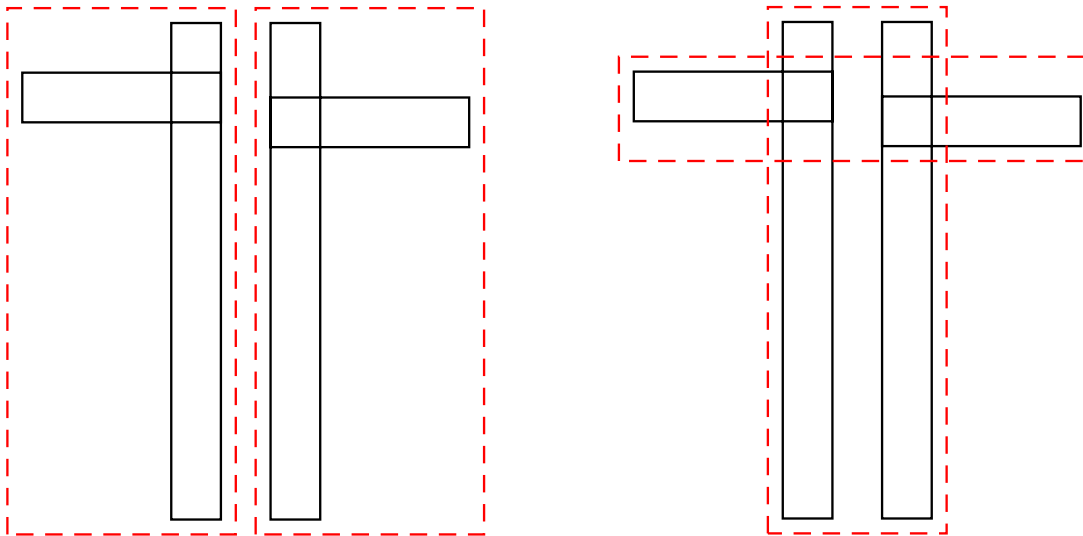

Heuristic: Minimize the totally covered area. But:

- **Exhaustive** search for the best split is infeasible.
- Guttman proposes two ways to **approximate** the search.
- Follow-up papers (e.g., the R*-tree) aim at improving the quality of node splits.

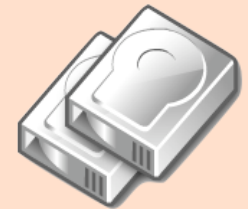

B+-trees...

... over composite keys

Point Quad Trees

Point (Equality) Search

Inserting Data

Region Queries

k-d Trees

Balanced Construction

K-D-B-Trees

K-D-B-Tree Operations

Splitting a Point Page

Splitting a Region Page

R-Trees

Searching and Inserting

Splitting R-Tree Nodes

UB-Trees

Bit Interleaving / Z-Ordering

B+-Trees over Z-Codes

Range Queries

Spaces with High Dimensionality

Wrap-Up

Splitting an R-Tree Node

To **split** an R-tree node, we generally have more than one alternative:

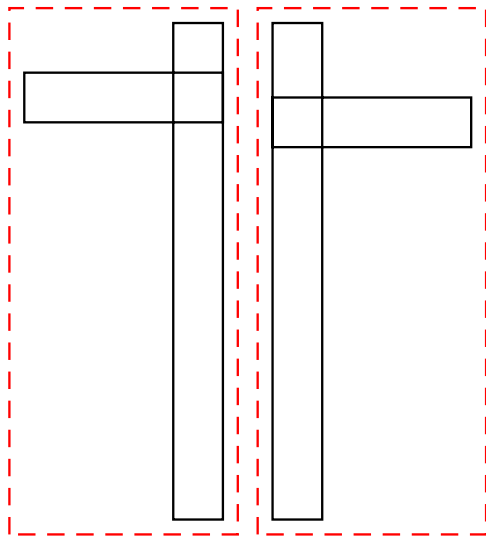

“bad” split

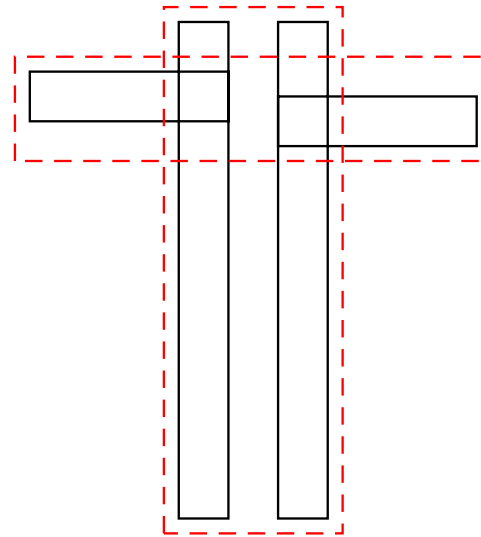

“good” split

Heuristic: Minimize the totally covered area. But:

- **Exhaustive** search for the best split is infeasible.
- Guttman proposes two ways to **approximate** the search.
- Follow-up papers (e.g., the R*-tree) aim at improving the quality of node splits.

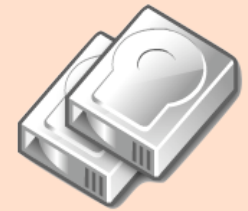

B+-trees...

... over composite keys

Point Quad Trees

Point (Equality) Search
Inserting Data
Region Queries

k-d Trees

Balanced Construction

K-D-B-Trees

K-D-B-Tree Operations
Splitting a Point Page
Splitting a Region Page

R-Trees

Searching and Inserting
Splitting R-Tree Nodes

UB-Trees

Bit Interleaving / Z-Ordering
B+-Trees over Z-Codes
Range Queries

Spaces with High Dimensionality

Wrap-Up

R-Tree: Deletes

All R-tree invariants (see 25) are maintained during **deletions**.

- 1 If an R-tree node n **underflows** (*i.e.*, less than d entries are left after a deletion), the whole node is **deleted**.
- 2 Then, all entries that existed in n are **re-inserted** into the R-tree.

Note that Step 1 may lead to a recursive deletion of n 's parent.

- Deletion, therefore, is a rather **expensive** task in an R-tree.

Spatial indexing in mainstream database implementations

- Indexing in commercial database systems is typically based on **R-trees**.
- Yet, only few systems implement them out of the box (*e.g.*, PostgreSQL). Most require the licensing/use of specific extensions.

Multi-Dimensional Indexing

Torsten Grust

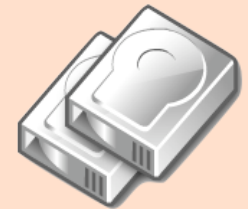

B+-trees...

... over composite keys

Point Quad Trees

Point (Equality) Search
Inserting Data
Region Queries

k-d Trees

Balanced Construction

K-D-B-Trees

K-D-B-Tree Operations
Splitting a Point Page
Splitting a Region Page

R-Trees

Searching and Inserting
Splitting R-Tree Nodes

UB-Trees

Bit Interleaving / Z-Ordering
B+-Trees over Z-Codes
Range Queries

Spaces with High Dimensionality

Wrap-Up

Bit Interleaving

- We saw earlier that a B⁺-tree over **concatenated** fields $\langle a, b \rangle$ does not help our case, because of the **asymmetry** between the role of a and b in the index key.
- What happens if we **interleave** the bits of a and b (hence, make the B⁺-tree “more symmetric”)?

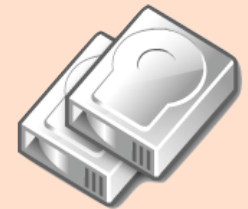
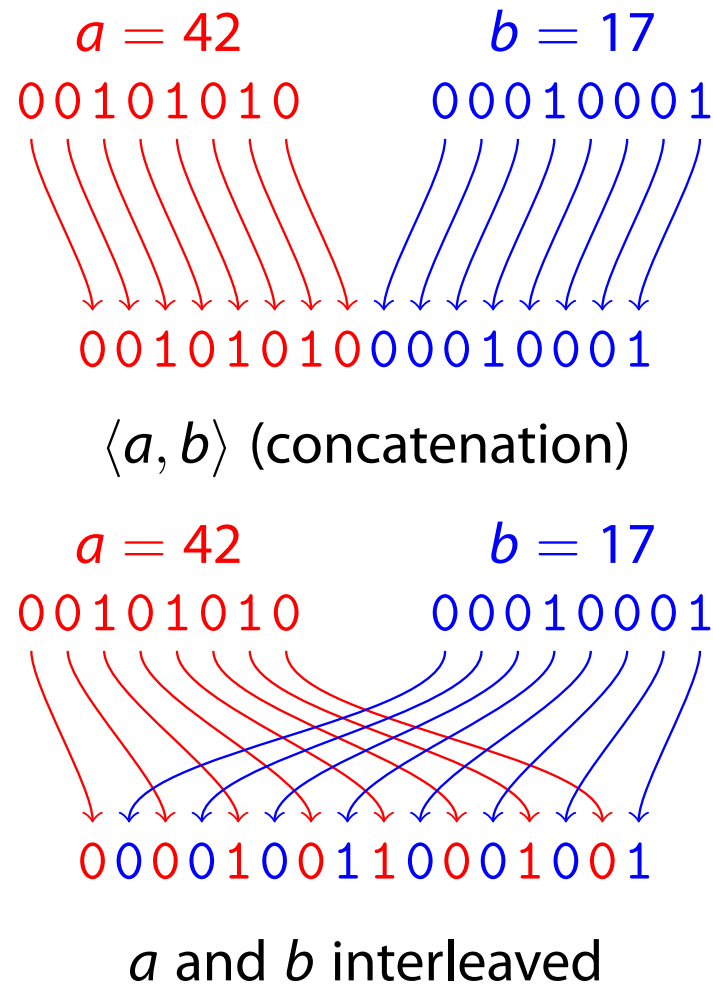

B⁺-trees...

... over composite keys

Point Quad Trees

Point (Equality) Search
Inserting Data
Region Queries

k-d Trees

Balanced Construction

K-D-B-Trees

K-D-B-Tree Operations
Splitting a Point Page
Splitting a Region Page

R-Trees

Searching and Inserting
Splitting R-Tree Nodes

UB-Trees

Bit Interleaving / Z-Ordering
B⁺-Trees over Z-Codes
Range Queries

Spaces with High Dimensionality

Wrap-Up

Z-Ordering

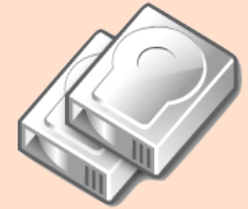

B+-trees...

... over composite keys

Point Quad Trees

Point (Equality) Search

Inserting Data

Region Queries

k-d Trees

Balanced Construction

K-D-B-Trees

K-D-B-Tree Operations

Splitting a Point Page

Splitting a Region Page

R-Trees

Searching and Inserting

Splitting R-Tree Nodes

UB-Trees

Bit Interleaving / Z-Ordering

B+-Trees over Z-Codes

Range Queries

Spaces with High Dimensionality

Wrap-Up

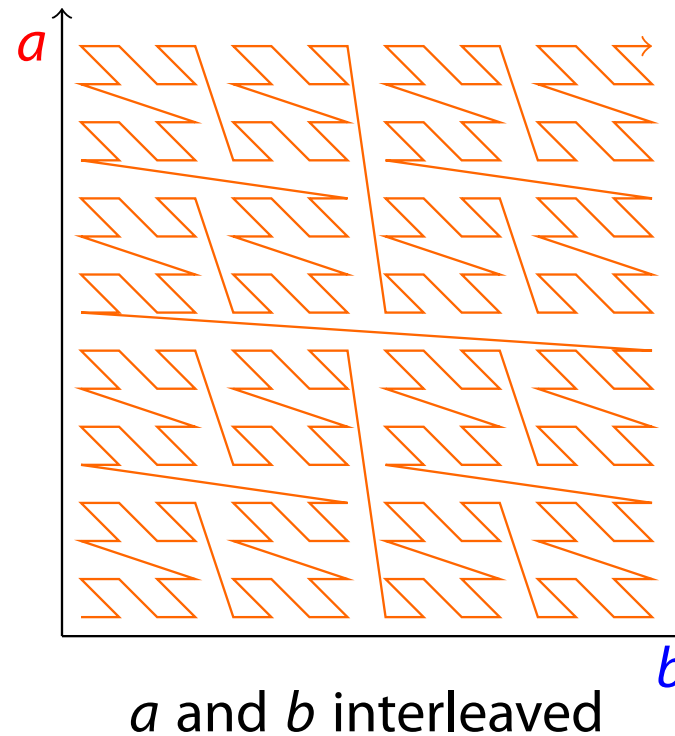
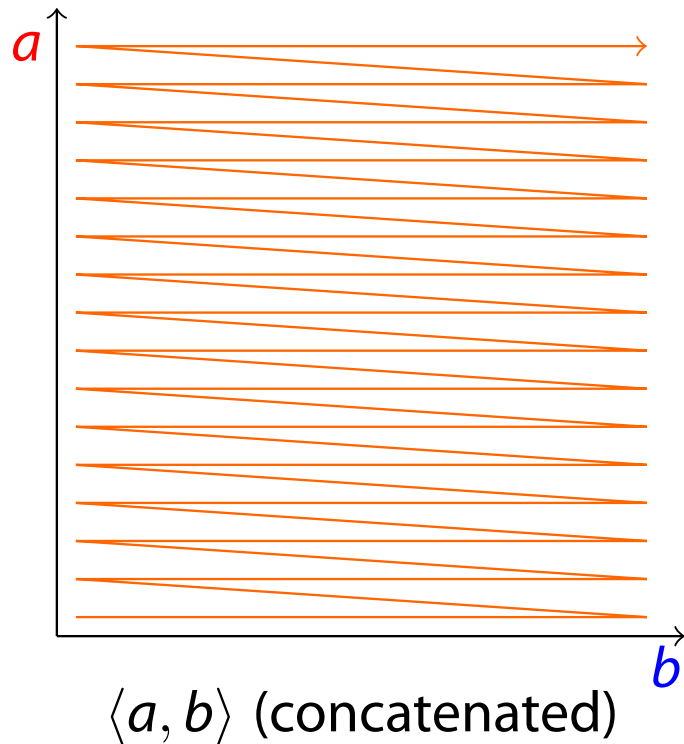

- Both approaches **linearize** all coordinates in the value space according to some **order**. ↗ see also slide 8
- Bit interleaving leads to what is called the **Z-order**.
- The Z-order (largely) preserves spatial **clustering**.

UB-Tree: B⁺-trees Over Z-Codes

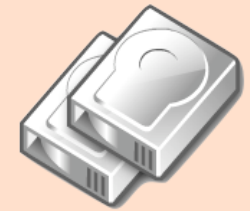

B⁺-trees...

... over composite keys

Point Quad Trees

Point (Equality) Search

Inserting Data

Region Queries

k-d Trees

Balanced Construction

K-D-B-Trees

K-D-B-Tree Operations

Splitting a Point Page

Splitting a Region Page

R-Trees

Searching and Inserting

Splitting R-Tree Nodes

UB-Trees

Bit Interleaving / Z-Ordering

B⁺-Trees over Z-Codes

Range Queries

Spaces with High Dimensionality

Wrap-Up

- Use a **B⁺-tree** to index Z-codes of multi-dimensional data.
- Each leaf in the B⁺-tree describes an **interval** in the **Z-space**.
- Each interval in the Z-space describes a **region** in the multi-dimensional data space:

UB-Tree: B⁺-tree over Z-codes

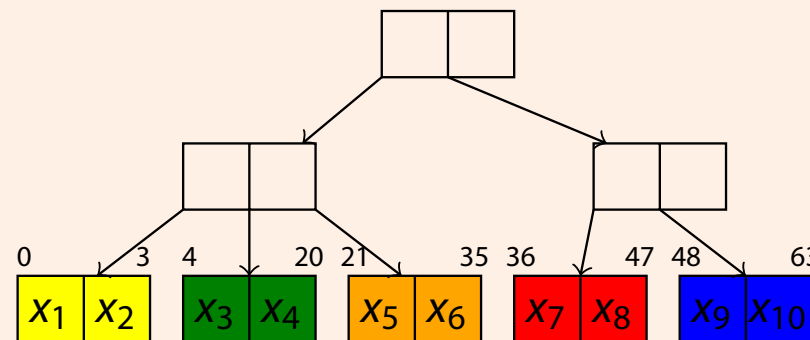
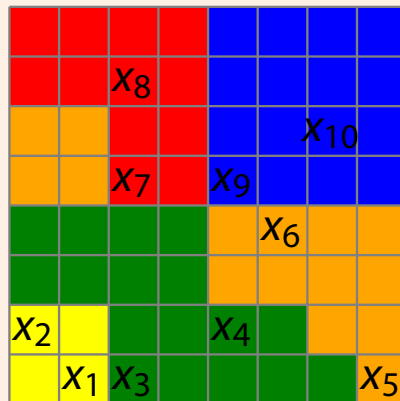

- To retrieve all data points in a query region Q , try to touch only those leaf pages that **intersect** with Q .

UB-Tree: Range Queries

After each page processed, perform an **index re-scan** (↗) to fetch the next leaf page that intersects with Q .

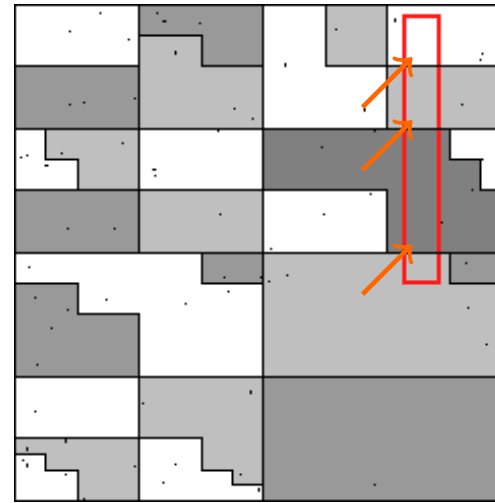

UB-tree range search (Function `ub_range(Q)`)

```
1 cur ←  $z(Q_{\text{bottom, left}})$  ;
2 while true do
   // search B+-tree page containing cur (↗ slide 0.0)
3  page ← search(cur);
4  foreach data point p on page do
5    if p is in  $Q$  then
6      append p to result ;
7  if region in page reaches beyond  $Q_{\text{top, right}}$  then
8    break ;
   // compute next Z-address using  $Q$  and data on current
   page
9  cur ← get_next_z_address( $Q$ , page);
```

Example by Volker Markl and Rudolf Bayer, taken from <http://mistral.in.tum.de/>

Multi-Dimensional Indexing

Torsten Grust

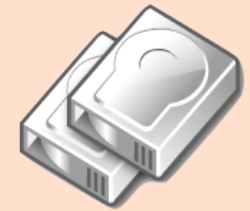

B+-trees...

... over composite keys

Point Quad Trees

Point (Equality) Search
Inserting Data
Region Queries

k-d Trees

Balanced Construction

K-D-B-Trees

K-D-B-Tree Operations
Splitting a Point Page
Splitting a Region Page

R-Trees

Searching and Inserting
Splitting R-Tree Nodes

UB-Trees

Bit Interleaving / Z-Ordering
B+-Trees over Z-Codes

Range Queries

Spaces with High Dimensionality

Wrap-Up

UB-Trees: Discussion

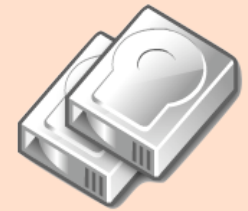

B+-trees...

... over composite keys

Point Quad Trees

Point (Equality) Search

Inserting Data

Region Queries

k-d Trees

Balanced Construction

K-D-B-Trees

K-D-B-Tree Operations

Splitting a Point Page

Splitting a Region Page

R-Trees

Searching and Inserting

Splitting R-Tree Nodes

UB-Trees

Bit Interleaving / Z-Ordering

B+-Trees over Z-Codes

Range Queries

Spaces with High Dimensionality

Wrap-Up

- Routine `get_next_z_address()` (return next Z-address lying in the query region) is non-trivial and depends on the shape of the Z-region.
- UB-trees are **fully dynamic**, a property inherited from the underlying B⁺-trees.
- The use of other **space-filling curves** to linearize the data space is discussed in the literature, too. *E.g.*, **Hilbert curves**.

 UB-trees have been commercialized in the Transbase[®] database system.

Spaces with High Dimensionality

For large k , all techniques that have been discussed become **ineffective**:

- For example, for $k = 100$, we get $2^{100} \approx 10^{30}$ partitions per node in a **point quad tree**. Even with billions of data points, **almost all** of these are empty.
- Consider a **really big** search region, cube-sized covering 95 % of the range along **each** dimension:

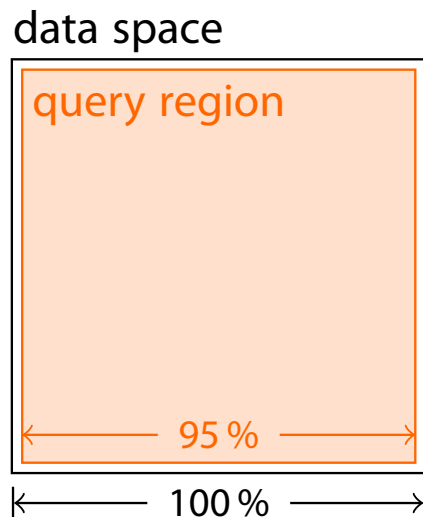

For $k = 100$, the probability of a point being in this region is still only $0.95^{100} \approx 0.59\%$.

- We experience the **curse of dimensionality** here.

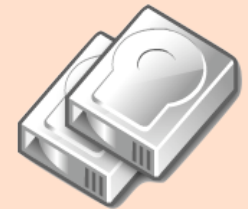

B+-trees...

... over composite keys

Point Quad Trees

Point (Equality) Search
Inserting Data
Region Queries

k-d Trees

Balanced Construction

K-D-B-Trees

K-D-B-Tree Operations
Splitting a Point Page
Splitting a Region Page

R-Trees

Searching and Inserting
Splitting R-Tree Nodes

UB-Trees

Bit Interleaving / Z-Ordering
B+-Trees over Z-Codes
Range Queries

Spaces with High Dimensionality

Wrap-Up

Page Selectivity for k -NN Search

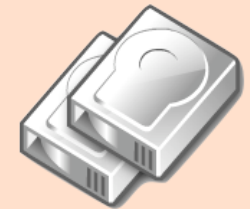

B+-trees...

... over composite keys

Point Quad Trees

Point (Equality) Search
Inserting Data
Region Queries

k-d Trees

Balanced Construction

K-D-B-Trees

K-D-B-Tree Operations
Splitting a Point Page
Splitting a Region Page

R-Trees

Searching and Inserting
Splitting R-Tree Nodes

UB-Trees

Bit Interleaving / Z-Ordering
B+-Trees over Z-Codes
Range Queries

Spaces with High Dimensionality

Wrap-Up

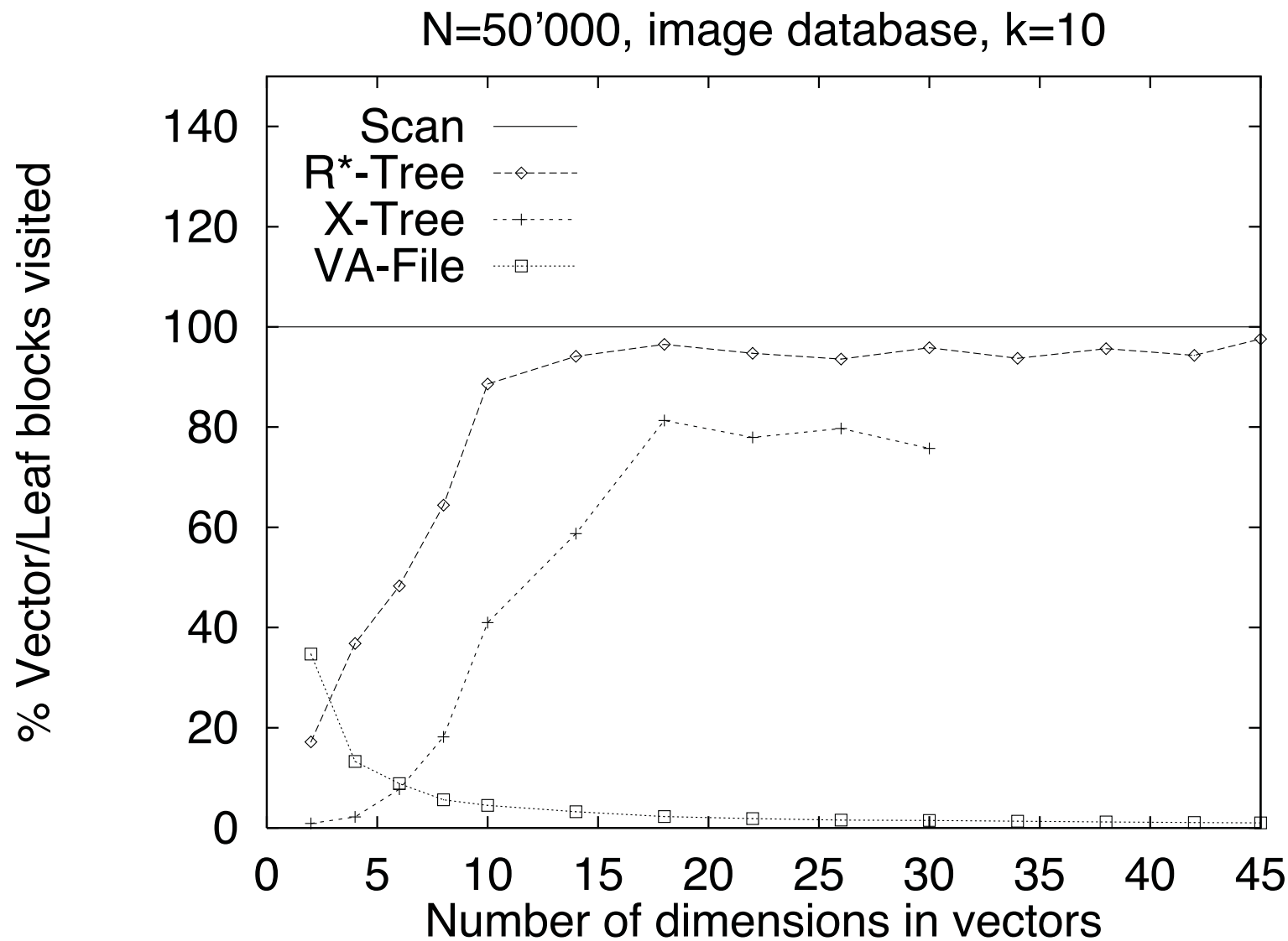

Data: Stephen Bloch. What's Wrong with High-Dimensionality Search. VLDB 2008.

Wrap-Up

Point Quad Tree

k -dimensional analogy to binary trees; main memory only.

k -d Tree, K-D-B-Tree

k -d tree: partition space one dimension at a time (round-robin); K-D-B-Tree: B^+ -tree-like organization with pages as nodes, nodes use a k -d-like structure internally.

R-Tree

regions within a node may overlap; fully dynamic; for point and region data.

UB-Tree

use space-filling curve (Z-order) to linearize k -dimensional data, then use B^+ -tree.

Curse Of Dimensionality

most indexing structures become ineffective for large k ; fall back to sequential scanning and approximation/compression.

Multi-Dimensional Indexing

Torsten Grust

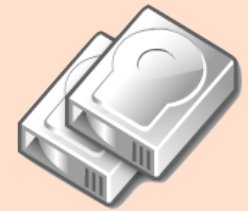

B+-trees...

... over composite keys

Point Quad Trees

Point (Equality) Search

Inserting Data

Region Queries

k -d Trees

Balanced Construction

K-D-B-Trees

K-D-B-Tree Operations

Splitting a Point Page

Splitting a Region Page

R-Trees

Searching and Inserting

Splitting R-Tree Nodes

UB-Trees

Bit Interleaving / Z-Ordering

B+-Trees over Z-Codes

Range Queries

Spaces with High Dimensionality

Wrap-Up